



TASK 30

STANDARDS/ GUIDELINES



VOLUME 40 CURBSIDES

PROJECT N° FC5801 - C / #7

 **Hartsfield-Jackson**
Atlanta International Airport®

Prepared by:  **AIS** |  **VALANCOURT**
INTERNATIONAL, LLC

1.0

GRAPHIC STANDARDS

VOLUME 4.0 CURBSIDES

- 1.1 Typography
- 1.2 Terminology/Symbology
- 1.3 Message Hierarchy
- 1.4 Arrow Standards
- 1.5 Color Standards

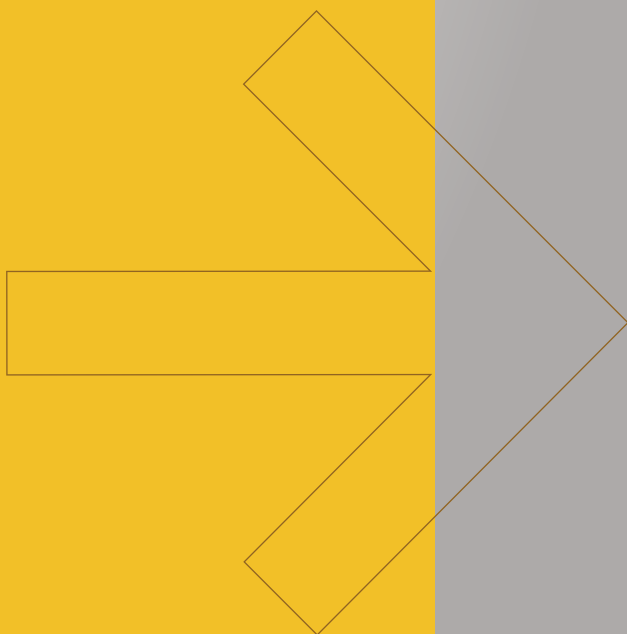

- 1.0 GRAPHIC STANDARDS
- 1.1 Typography 1-01
 - Line Spacing 1-02
- 1.2 Terminology / Symbology
 - Principal Facilities 1-03
 - Fundamental Functions 1-04
 - Dynamic Message Terminology 1-05
 - Specialty Icons – Primary Identification 1-06
 - Specialty Icons – Secondary Identification 1-07
- 1.3 Message Hierarchy
 - Message Functions 1-08
 - Message Hierarchy Examples 1-09
- 1.4 Arrow Standards 1-10
- 1.5 Color Standards
 - Color Specifications 1-11
 - Color Applications - Primary Identification - Overhead 1-12
 - Color Applications - Primary Identification - Freestanding 1-13

#	REVISION	DATE
1	Updated	07/25/17
2	Updated	10/20/17

ABCDEFGHIJKLMNOPQRSTUVWXYZ
 abcdefghijklmnopqrstuvwxyz
 0123456789@#%^&*()::

Gotham Book

.75X

x Curbside Check - In

X = Letter Cap. Height

Letter Spacing Correct - Kerning at "- 49 points"

Curbside Check - in

Letter Spacing Too Wide

Curbside Check - In

Letter Spacing Too Close

Line Spacing

#	REVISION	DATE
1	Updated	07/25/17
2	Updated	10/20/17

Curbside Check - In
 Spanish Translation

Terminal North
 Spanish Translation

ALIGNED

Line Spacing Examples

2x
 CENTER ALIGN

1.5x

Curbside Check - In
 Spanish Translation .5x

.5x .5x

Spacing Example between arrow, symbol and messages

Ground
 Transportation

Baggage Claim

ALIGNED

Unrelated Line Spacing Examples

RELATED LINES OF TEXT

UNRELATED LINES OF TEXT

Principal Facilities

#	REVISION	DATE
1	Updated	07/25/17
2	Updated	10/20/17

TERMINOLOGY

SYMBOL

INTERIOR APPLICATIONS

Terminal North



- Identifies Terminal North
- Primary information

Terminal South



- Identifies Terminal South
- Primary information

International Terminal



- Identifies International Terminal
- Primary information

Fundamental Functions

#	REVISION	DATE
1	Updated	07/25/17
2	Updated	10/20/17

TERMINOLOGY

SYMBOL

EXTERIOR APPLICATIONS

Departures



- Identifies portion of Curbsides that is designed as Departures

Arrivals



- Identifies portion of Curbsides that is designed as Arrivals

Curbside Check - In



- Identifies portion of Curbsides that is designed as Curbside Check - In

Ticketing / Check - In



- Identifies portion of Curbsides that is designed as Ticketing / Check - In
- Is always used in conjunction with Terminal / Curbsides

Baggage Claim



- Identifies portion of Curbsides that is designed as Baggage Claim

Passenger Pick - Up



- Identifies portion of Curbsides that is designed as Passenger Pick - Up
- Is always used in conjunction with Terminal / Curbsides

(Passenger Drop - Off)

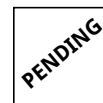

- Identifies portion of Curbsides that is designed as Passenger Drop - Off
- Is always used in conjunction with Terminal / Curbsides

Dynamic Message Terminology

#	REVISION	DATE
1	Updated	07/25/17
2	Updated	10/20/17

TERMINOLOGY

Terminal North

Terminal South

International Terminal

Departures

Arrivals

Curbside Check - In

Ticketing / Check - In

Baggage Claim

*Note:
Dynamic messages shown are samples only.
Owner will review / confirm all messages.*

Specialty Icons - Primary Identification

#	REVISION	DATE
1	Updated	07/25/17
2	Updated	10/20/17

TERMINOLOGY

ICONS

APPLICATIONS

Curbside / Check - In



- Identifies Curbside / Check - Ins
- Is always used in conjunction with the Curbsides
- Not used in the Terminal, Concourses or Transportation Malls
 - Terminal North - White on ■ Blue (Pantone 2935C)
 - Terminal South - White on ■ Red (Pantone 1795C)
 - International Terminal - ■ Yellow (Pantone 123C) on ■ Black (Pantone Black)

Baggage Claim



- Identifies Baggage Claim
- Is always used in conjunction with the Curbsides
- Not used in Concourses or Transportation Malls
 - Terminal North - White on ■ Blue (Pantone 2935C)
 - Terminal South - White on ■ Red (Pantone 1795C)
 - International Terminal - ■ Yellow (Pantone 123C) on ■ Black (Pantone Black)

Passenger Pick - Up



- Identifies Passenger Pick - Up
- Is always used in conjunction with the Terminal / Curbsides
- Not used in Concourses or Transportation Malls
 - Terminal North - White on ■ Blue (Pantone 2935C)
 - Terminal South - White on ■ Red (Pantone 1795C)
 - International Terminal - ■ Yellow (Pantone 123C) on ■ Black (Pantone Black)

Departures



- Identifies Departures
- Is always use in conjunction with Curbsides
- Not used in Concourses or Transportation Malls
 - Terminal North - White on ■ Blue (Pantone 2935C)
 - Terminal South - White on ■ Red (Pantone 1795C)
 - International Terminal - ■ Yellow (Pantone 123C) on ■ Black (Pantone Black)

Arrivals



- Identifies Arrivals
- Is always use in conjunction with Curbsides
- Not used in Concourses or Transportation Malls
 - Terminal North - White on ■ Blue (Pantone 2935C)
 - Terminal South - White on ■ Red (Pantone 1795C)
 - International Terminal - ■ Yellow (Pantone 123C) on ■ Black (Pantone Black)

Specialty Icons - Secondary Identification

#	REVISION	DATE
1	Updated	07/25/17
2	Updated	10/20/17

TERMINOLOGY

SYMBOL

INTERIOR APPLICATIONS

Terminal North



- Identifies Terminal North
- Is always used in conjunction with the Curbsides

Terminal South



- Identifies Terminal South
- Is always used in conjunction with the Curbsides

International Terminal



- Identifies International Terminal
- Is always used in conjunction with the Curbsides

Message Function

#	REVISION	DATE
1	Updated	07/25/17
2	Updated	10/20/17

	PRIMARY	SECONDARY	TERTIARY
Directional			
Identification	Terminal North Terminal South International Terminal Baggage Claim Departure Arrivals	Passenger Pick - Up Passenger Drop - Off Smoking Area	
Information	Departures Arrivals	Passenger Pick - Up Passenger Drop - Off N1, N2, N3, N4, N5, N6 S1, S2, S3, S4, S5, S6 <i>(Airline Names)</i>	
Regulatory or Safety	Active Loading and Unloading Only		

#	REVISION	DATE
1	Updated	07/25/17
2	Updated	10/20/17

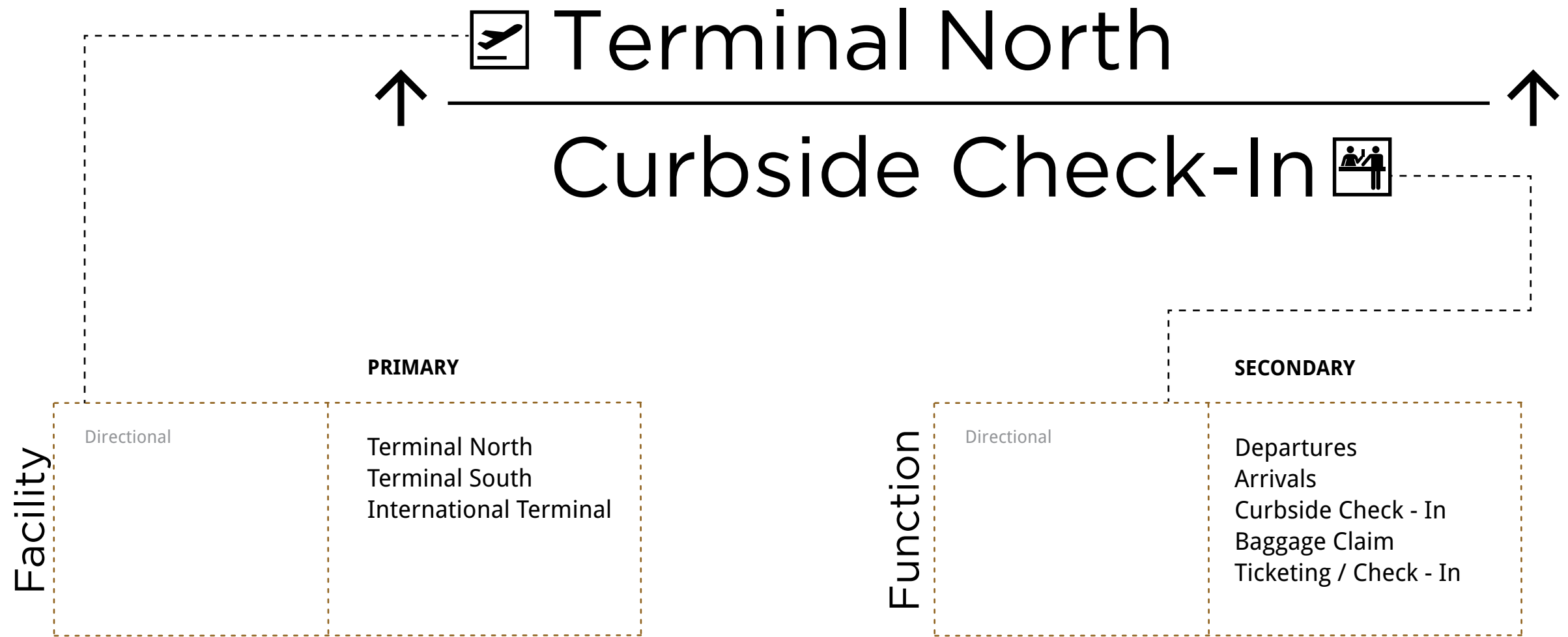

Curbsides Message Hierarchy Example
SCALE: NTS

1.0 GRAPHIC STANDARDS

1.4 Arrow Standards

#	REVISION	DATE
1	Updated	07/25/17
2	Updated	10/20/17

These figures define the arrow orientations and size that shall be used throughout Curbsides / Ground Transportation.

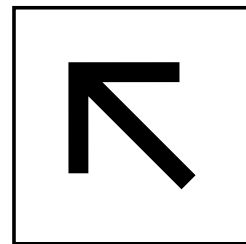

Up to the Left
10 o'clock

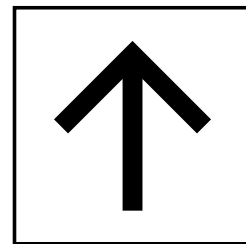

Up and/or Straight
Ahead / 12 o'clock

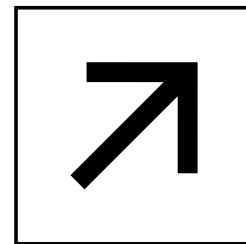

Up to the Right
2 o'clock

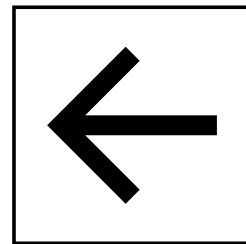

To the left
9 o'clock

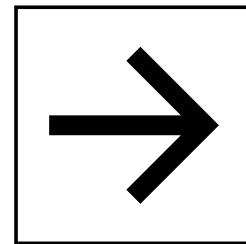
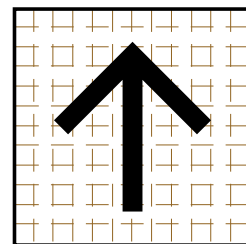

To the Right
3 o'clock

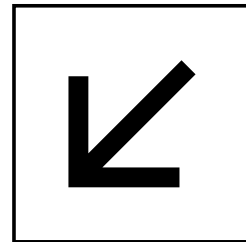

Down to the Left
7 o'clock

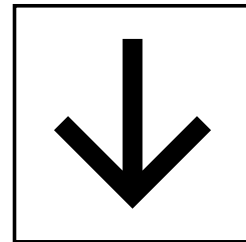

Down
6 o'clock

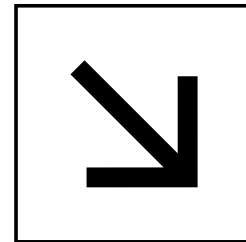

Down to the Right
5 o'clock

Arrows Orientation
SCALE: NTS

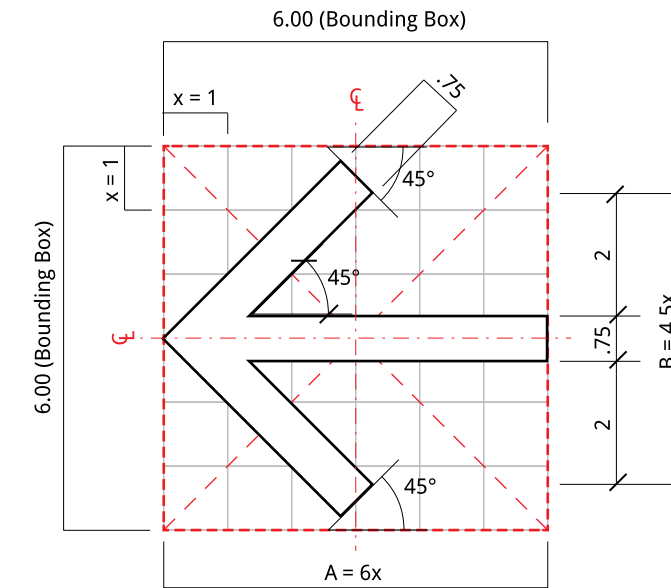

Straight Arrow:
Use for arrows angled at: 0°, 90°, 180°, 270°

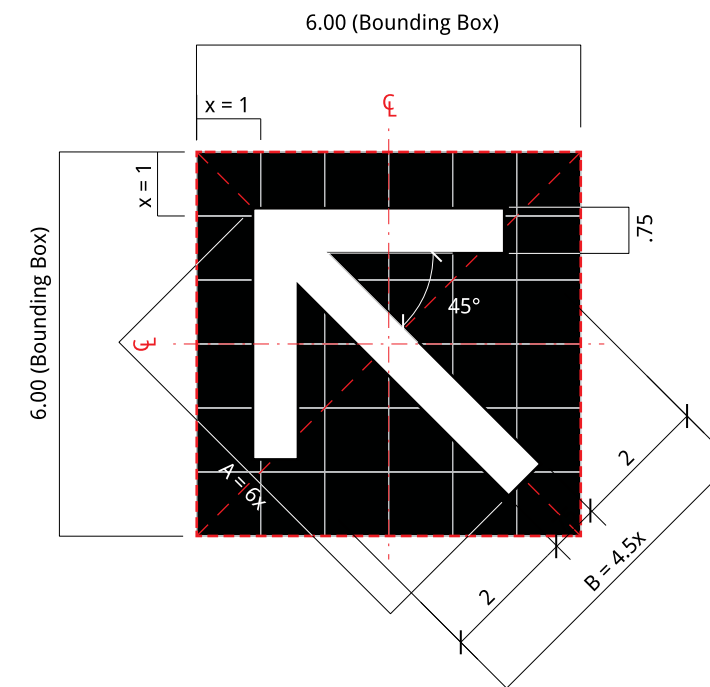









Angled Arrow:
Use for arrows angled at: 45°, 135°, 225°, 315°

Arrows Sizes
SCALE: NTS

Color Specifications

#	REVISION	DATE
1	Updated	07/25/17
2	Updated	10/20/17

This section of the document shall specify colors and applications that are to be used in the Curbsides.

COLOR APPLICATION	COLOR	PANTONE Equivalent	MATERIAL Equivalent
Curbsides Identifications			
- North	Blue	 Pantone 2935C	Exterior Sign Grade Translucent Polycarbonate
- South	Red	 Pantone 1795C	Exterior Sign Grade Translucent Polycarbonate
- International	Yellow	 Pantone 123C	Exterior Sign Grade Translucent Polycarbonate
Sign Panel	N/A	N/A	 Satin Brushed Aluminum
Accent Panels			
- North	Blue	 Pantone 2935C	Exterior Sign Grade Translucent Polycarbonate
- South	Red	 Pantone 1795C	Exterior Sign Grade Translucent Polycarbonate
- International	Yellow	 Pantone 123C	Exterior Sign Grade Translucent Polycarbonate
Arrow	White	White	Exterior Sign Grade Translucent Polycarbonate
Symbol on Message Panel	White	White	Exterior Sign Grade Translucent Polycarbonate
Message Panel Color	Black	 Process Black	Exterior Sign Grade Translucent Polycarbonate
English Text	White	White	Exterior Sign Grade Translucent Polycarbonate

*or approved equal

Note: Color palette should not be substituted / replaced.

Color Applications - Primary Identification - Overhead

#	REVISION	DATE
1	Updated	07/25/17
2	Updated	10/20/17

Sign Finishes



Color Application

COLOR APPLICATION	COLOR
1 Terminal Identifications - North - South - International	Pantone 2935C on Satin Brushed Aluminum Background Pantone 1795C on Satin Brushed Aluminum Background Pantone 123C on Black Background (Pantone Black)
2 Curbsides Function Symbol - North - South - International	White on Pantone 2935C Background White on Pantone 1795C Background Pantone 123C on Black Background (Pantone Black)
3 Terminal Function Symbol - North - South - International	White on Pantone 2935C Background White on Pantone 1795C Background Pantone 123C on Black Background (Pantone Black)

Color Application Examples
 SCALE: NTS
 Note: Color palette should not be substituted / replaced.

#	REVISION	DATE
1	Updated	07/25/17
2	Updated	10/20/17

Color Applications – Primary Identification - Freestanding

Sign Finishes



Color Application

COLOR APPLICATION	COLOR
1 Terminal Identifications - Terminal North - Terminal South - International Terminal	Pantone 2935C on Satin Brushed Aluminum Background Pantone 1795C on Satin Brushed Aluminum Background Pantone 123C on Black Background (Pantone Black)
2 Curbsides Function Symbol - Terminal North - Terminal South - International Terminal	Pantone 2935C on Satin Brushed Aluminum Background Pantone 1795C on Satin Brushed Aluminum Background Pantone 123C on Black Background (Pantone Black)
3 Symbol	White
4 Background	Process Black
5 English Text	White

Sign Message Panel Finishes

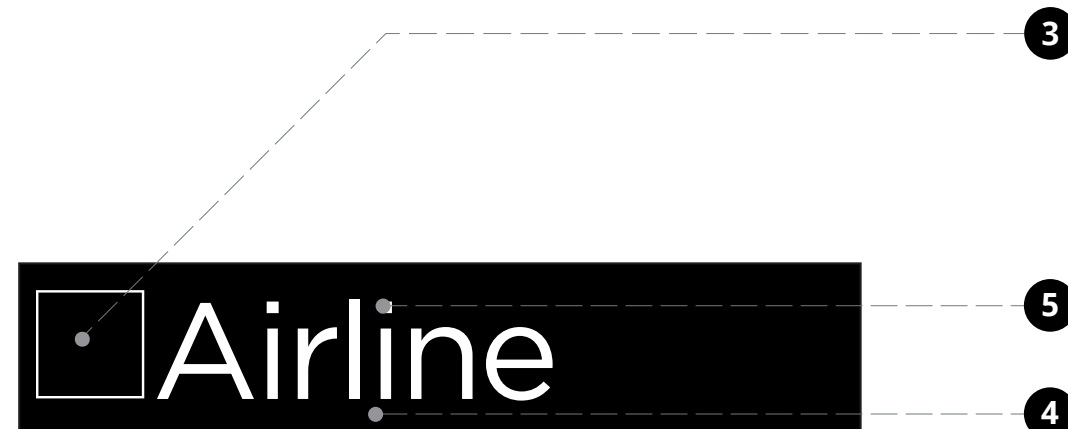

Color Application Examples
 SCALE: NTS
 Note: Color palette should not be substituted / replaced.

2.0

SIGN TYPES CURBSIDES

VOLUME 4.0 CURBSIDES

- 2.1 Sign Type Series Number
- 2.2 Sign Type Identification System
- 2.3 Sign Type Index
- 2.4 Sign Type Layouts



2.0 SIGN TYPES

- 2.1 Sign Type Series Numbers 2-01
- 2.2 Sign Type Identification System 2-02
- 2.3 Sign Type Index 2-03
- 2.4 Sign Type Layouts
 - ST-400 - Primary Identification - Freestanding 2-08
 - ST-402 - Primary Identification (ALTERNATE) - Freestanding 2-10
 - ST-404 - Primary Identification (ALTERNATE) - Ceiling Mounted 2-12
 - ST-416 - Primary Identification - Ceiling Mounted 2-13
 - ST-442 - Primary Identification - Ceiling Mounted 2-14
 - ST-446 - Airline Identification - Canopy Suspended 2-16
 - ST-448 - Primary Identification - Surface Mounted 2-17
 - ST-450 - Door Identification - Canopy Mounted 2-18

 - ST-454 - Secondary Identification (ALTERNATE) - Flag Mounted 2-19
 - ST-460 - Secondary Identification - Flag Mounted 2-20
 - ST-462 - Secondary Identification - Flag Mounted 2-22

 - ST-464 - Regulatory Identification - Flag Mounted 2-24
 - ST-470 - Door Identification (ALTERNATE) - First Surface on Glass 2-26
 - ST-472 - Terminal Identification - First Surface on Glass..... 2-27
 - ST-474 - Regulatory Identification - First Surface on Glass 2-29

2.0 SIGN TYPES

#	REVISION	DATE
1	Updated	07/25/17
2	Updated	10/20/17

2.1 Sign Type Series Numbers

- **100 Series** – Terminals (Domestic / International)
 - 100 - 129 – Primary Directional
 - 130 - 139 – Secondary Directional
 - 140 - 149 – Primary Identification
 - 150 - 159 – Secondary Identification
 - 160 - 169 – Primary Informational
 - 170 - 179 – Secondary Informational

- **200 Series** – Concourses
 - 200 - 229 – Primary Directional
 - 230 - 239 – Secondary Directional
 - 240 - 249 – Primary Identification
 - 250 - 259 – Secondary Identification
 - 260 - 269 – Primary Informational
 - 270 - 279 – Secondary Informational

- **300 Series** – Transportation Malls
 - 300 - 329 – Primary Directional
 - 330 - 339 – Secondary Directional
 - 340 - 349 – Primary Identification
 - 350 - 359 – Secondary Identification
 - 360 - 369 – Primary Informational
 - 370 - 379 – Secondary Informational

- **400 Series** – Curbsides (Domestic / International)
 - 400 - 429 – Primary Directional
 - 430 - 439 – Secondary Directional
 - 440 - 449 – Primary Identification
 - 450 - 459 – Secondary Identification
 - 460 - 469 – Primary Informational
 - 470 - 479 – Secondary Informational

- **500 Series** – Ground Transportation (Domestic / International)
 - 500 - 529 – Primary Directional
 - 530 - 539 – Secondary Directional
 - 540 - 549 – Primary Identification
 - 550 - 559 – Secondary Identification
 - 560 - 569 – Primary Informational
 - 570 - 579 – Secondary Informational

- **600 Series** – Parking (Domestic / International)
 - 600 - 616 – Primary Directional - Vehicular
 - 618 - 628 – Primary Identification - Vehicular
 - 630 - 635 – Secondary Identification - Vehicular
 - 636 - 639 – Primary Informational - Vehicular

 - 640 - 649 – Primary Directional - Pedestrian
 - 650 - 659 – Primary Identification - Pedestrian
 - 660 - 669 – Primary Informational - Pedestrian
 - 670 - 679 – Secondary Informational - Pedestrian

 - 680 - 684 – Primary Directional - Surface
 - 686 - 690 – Primary Identification - Surface
 - 692 - 699 – Primary Informational - Surface

- **700 Series** – Roadways (Domestic / International)
 - 700 - 729 – Primary Directional
 - 730 - 739 – Secondary Directional
 - 740 - 749 – Primary Identification
 - 750 - 759 – Secondary Identification
 - 760 - 769 – Primary Informational
 - 770 - 779 – Secondary Informational

Project:



HARTSFIELD-JACKSON ATLANTA INTERNATIONAL AIRPORT
Wayfinding Signage Masterplan

Document Title:

Task 3.0 - STANDARDS / GUIDELINES
Project No.: FC5801 - C / #7

Issued as: **Final** Date: **October 2017**

REV. 07/25/17
REV. 10/20/17
REV. _____

Prepared by:



VOLUME 4.0
CURBSIDES
2.1 Sign Type Series Numbers

PAGE

2-01

Sign Location Indicator - Curbsides

#	REVISION	DATE
1	Updated	07/25/17
2	Updated	10/20/17

2.2-1 Sign Location Indicator

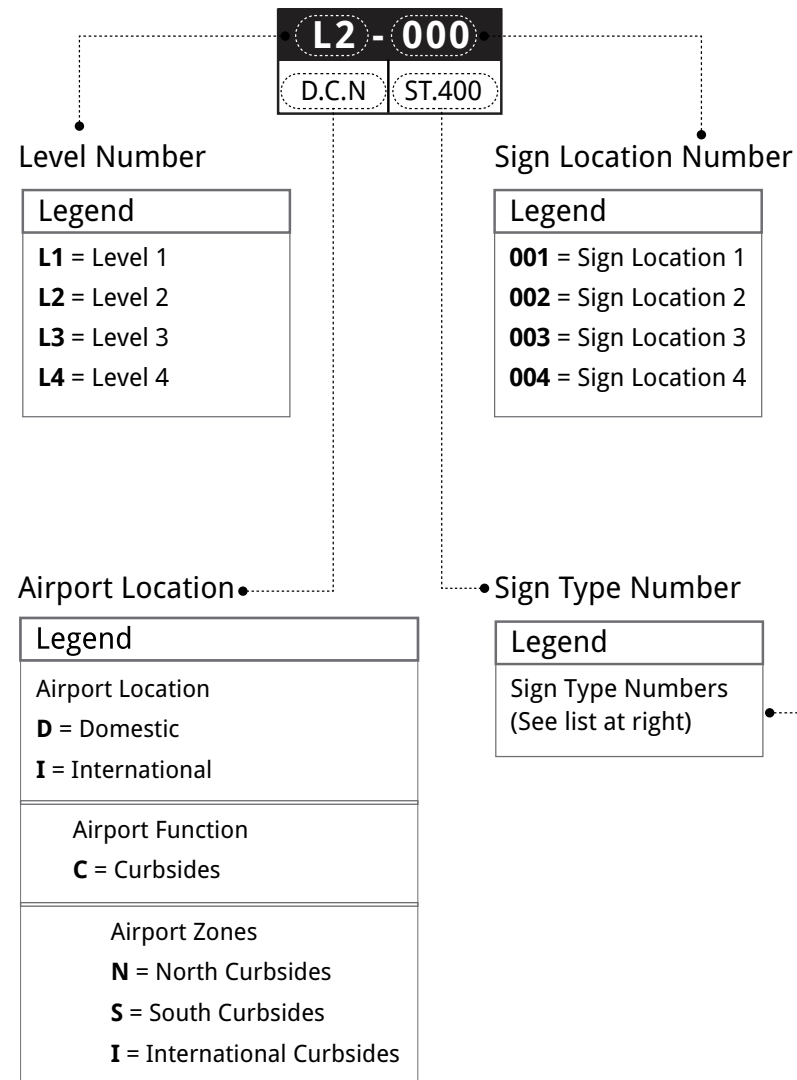

2.2-2 Sign Type Series Numbers - Curbsides



Sign Type 400 Series - Curbsides (Domestic / International)
ST. 400 - ST. 429 – Primary Directional
ST. 430 - ST. 439 – Secondary Directional
ST. 440 - ST. 449 – Primary Identification
ST. 450 - ST. 459 – Secondary Identification
ST. 460 - ST. 469 – Primary Informational
ST. 470 - ST. 479 – Secondary Informational

2.0 SIGN TYPES

#	REVISION	DATE
1	Updated	07/25/17
2	Updated	10/20/17

2.3 Sign Type Index

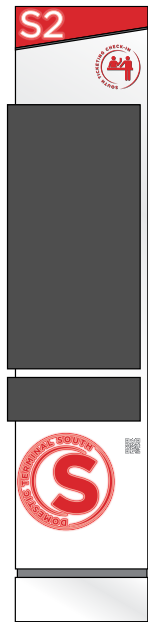
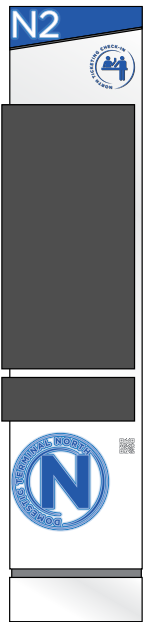
ST - 400 Primary Identification (Dynamic)

South Curbsides	North Curbsides	International Curbsides
		
<ul style="list-style-type: none"> - Freestanding / 2 sided / 1 Level of Messaging with Dynamic Display - Overall dimensions: 14'- 0" H x 3'-2" W x 6" D - Provides Primary Identification - For use in South Curbsides only : Accent Color Red - Pantone 1795 	<ul style="list-style-type: none"> - Freestanding / 2 sided / 1 Level of Messaging with Dynamic Display - Overall dimensions: 14'- 0" H x 3'-2" W x 6" D - Provides Primary Identification - For use in North Curbsides only : Accent Color Blue - Pantone 2935 	<ul style="list-style-type: none"> - Freestanding / 2 sided / 1 Level of Messaging with Dynamic Display - Overall dimensions: 14'- 0" H x 3'-2" W x 6" D - Provides Primary Identification - For use in International Curbsides only : Accent Color Yellow - Pantone 123

ST - 402 Primary Identification (Dynamic)

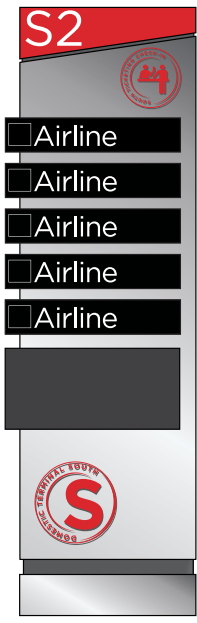
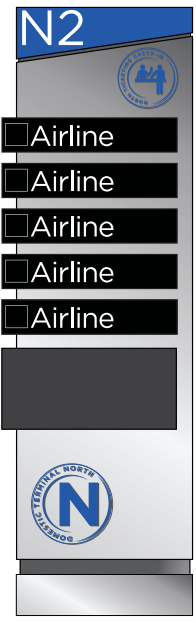
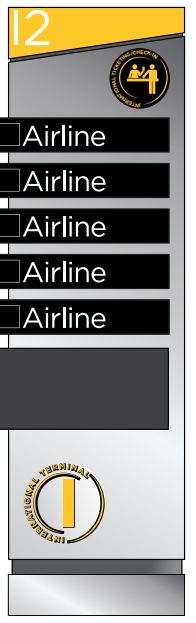
South Curbsides	North Curbsides	International Curbsides
		
<ul style="list-style-type: none"> - Freestanding / 2 Sided / 5 Levels of Messaging with Dynamic Display - Overall dimensions: 7'- 6" H x 2'-4" W x 4" D - Provides Primary Identification - For use in South Curbsides only : Accent Color Red - Pantone 1795 	<ul style="list-style-type: none"> - Freestanding / 2 Sided / 5 Levels of Messaging with Dynamic Display - Overall dimensions: 7'- 6" H x 2'-4" W x 4" D - Provides Primary Identification - For use in North Curbsides only : Accent Color Blue - Pantone 2935 	<ul style="list-style-type: none"> - Freestanding / 2 Sided / 5 Levels of Messaging with Dynamic Display - Overall dimensions: 7'- 6" H x 2'-4" W x 4" D - Provides Primary Identification - For use in International Curbsides only : Accent Color Yellow - Pantone 123

2.0 SIGN TYPES

#	REVISION	DATE
1	Updated	07/25/17
2	Updated	10/20/17

2.3 Sign Type Index

ST - 404 Primary Identification (ALTERNATE)		
South Curbsides	North Curbsides	International Curbsides
<ul style="list-style-type: none"> - Ceiling Suspended / 1 Sided / 1 Level of Messaging - Overall dimensions: 2'- 0" H x 15'-5" W x 3" D - Provides Primary Identification - For use in South Curbsides only : Accent Color Red - Pantone 1795 	<ul style="list-style-type: none"> - Ceiling Suspended / 1 Sided / 1 Level of Messaging - Overall dimensions: 2'- 0" H x 15'-5" W x 3" D - Provides Primary Identification - For use in North Curbsides only : Accent Color Blue - Pantone 2935 	<ul style="list-style-type: none"> - Ceiling Suspended / 1 Sided / 1 Level of Messaging - Overall dimensions: 2'- 0" H x 15'-5" W x 3" D - Provides Primary Identification - For use in International Curbsides only : Accent Color Yellow - Pantone 123
ST - 416 Primary Identification (Dynamic)		
South Curbsides	North Curbsides	International Curbsides
<ul style="list-style-type: none"> - Ceiling Suspended / 1 Sided / 1 Level of Messaging - Overall dimensions: 3'- 11" H x 11'-1/2" W x 7" D - Provides Primary Identification - For use in South Curbsides only : Accent Color Red - Pantone 1795 	<ul style="list-style-type: none"> - Ceiling Suspended / 1 Sided / 1 Level of Messaging - Overall dimensions: 3'- 11" H x 11'-1/2" W x 7" D - Provides Primary Identification - For use in Terminal North only : Accent Color Blue - Pantone 2935 	<ul style="list-style-type: none"> - Ceiling Suspended / 1 Sided / 1 Level of Messaging - Overall dimensions: 3'- 11" H x 11'-1/2" W x 7" D - Provides Primary Identification - For use in International Curbsides only : Accent Color Yellow - Pantone 123
ST - 442 Primary Identification (Dynamic)		
South Curbsides	North Curbsides	International Curbsides
<ul style="list-style-type: none"> - Overall dimensions: 2'- 9" H x 17'- 0" W x 1'- 4" D - 2 Sided - Provides Terminal South Information - For use in Terminal South only : Accent Color Red - Pantone 1795 	<ul style="list-style-type: none"> - Overall dimensions: 2'- 9" H x 17'- 0" W x 1'- 4" D - 2 Sided - Provides Terminal North Information - For use in Terminal South only : Accent Color Blue - Pantone 2935 	<ul style="list-style-type: none"> - Overall dimensions: 2'- 9" H x 17'- 0" W x 1'- 4" D - 2 Sided - Provides International Terminal Information - For use in Terminal South only : Accent Color Yellow - Pantone 123
ST-446 Airline Identification (ALTERNATE)		
South Curbsides	North Curbsides	International Curbsides
<ul style="list-style-type: none"> - Canopy Suspended / 1 Sided / 1 Level of Messaging - Overall dimensions: 1'- 8" H x 5'- 0" W x 2 1/2" D - Provides Primary Identification - For use in South Curbsides only 	<ul style="list-style-type: none"> - Canopy Suspended / 1 Sided / 1 Level of Messaging - Overall dimensions: 1'- 8" H x 5'- 0" W x 2 1/2" D - Provides Primary Identification - For use in North Curbsides only 	<ul style="list-style-type: none"> - Canopy Suspended / 1 Sided / 1 Level of Messaging - Overall dimensions: 1'- 8" H x 5'- 0" W x 2 1/2" D - Provides Primary Identification - For use in International Curbsides only

2.0 SIGN TYPES

#	REVISION	DATE
1	Updated	07/25/17
2	Updated	10/20/17

2.3 Sign Type Index

ST - 448 Primary Identification (ALTERNATE)		
South Curbsides	North Curbsides	International Curbsides
<ul style="list-style-type: none"> - Surface Mount at Terminal Entrances / 1 Sided / 1 Level of Messaging - Overall dimensions: 6" H x Varied Widths x 3/4" D - Provides Primary Identification - For use in South Curbsides only : Accent Color Red - Pantone 1795 	<ul style="list-style-type: none"> - Surface Mount at Terminal Entrances / 1 Sided / 1 Level of Messaging - Overall dimensions: 6" H x Varied Widths x 3/4" D - Provides Primary Identification - For use in North Curbsides only : Accent Color Blue - Pantone 2935 	<ul style="list-style-type: none"> - Surface Mount at Terminal Entrances / 1 Sided / 1 Level of Messaging - Overall dimensions: 6" H x Varied Widths x 3/4" D - Provides Primary Identification - For use in International Curbsides only : Accent Color Yellow - Pantone 123

ST - 450 Primary Identification		
South Curbsides	North Curbsides	International Curbsides
<ul style="list-style-type: none"> - Canopy Mounted / 1 Sided / 1 Level of Messaging - Overall dimensions: 1'- 8" H x W (varies) x 1'- 4" D - Provides Door Identification - For use in South Curbsides only : Front face painted Silver. Accent Color Red - Pantone 1795 	<ul style="list-style-type: none"> - Canopy Mounted / 1 Sided / 1 Level of Messaging - Overall dimensions: 1'- 8" H x W (varies) x 1'- 4" D - Provides Door Identification - For use in South Curbsides only : Front face painted Silver. Accent Color Blue - Pantone 2935 	<ul style="list-style-type: none"> - Canopy Mounted / 1 Sided / 1 Level of Messaging - Overall dimensions: 1'- 8" H x W (varies) x 1'- 4" D - Provides Door Identification - For use in South Curbsides only : Front face painted Silver. Accent Color Yellow - Pantone 123

ST - 454 Door Identification (ALTERNATE)		
South Curbsides	North Curbsides	International Curbsides
<ul style="list-style-type: none"> - Flag Mounted / 2 Sided / 1 Levels of Messaging - Overall dimensions: 1'- 4" H x 2'- 0" W x 3 1/2" D - Provides Secondary Identification - For use in South Curbsides only 	<ul style="list-style-type: none"> - Flag Mounted / 2 Sided / 1 Levels of Messaging - Overall dimensions: 1'- 4" H x 2'- 0" W x 3 1/2" D - Provides Secondary Identification - For use in North Curbsides only 	<ul style="list-style-type: none"> - Flag Mounted / 2 Sided / 1 Levels of Messaging - Overall dimensions: 1'- 4" H x 2'- 0" W x 3 1/2" D - Provides Secondary Identification - For use in International Curbsides only



ST - 460 Identification Sign		
South Curbsides	North Curbsides	International Curbsides
<ul style="list-style-type: none"> - Flag Mounted / 2 Sided / 2 Levels of Messaging - Overall dimensions: 1'- 6" H x 2'- 4-3/4" W x 7" D - Provides Secondary Identification - For use in South Curbsides only : Accent Color Red - Pantone 1795 	<ul style="list-style-type: none"> - Flag Mounted / 2 Sided / 2 Levels of Messaging - Overall dimensions: 1'- 6" H x 2'- 4-3/4" W x 7" D - Provides Secondary Identification - For use in North Curbsides only : Accent Color Blue - Pantone 2935 	<ul style="list-style-type: none"> - Flag Mounted / 2 Sided / 2 Levels of Messaging - Overall dimensions: 1'- 6" H x 2'- 4-3/4" W x 7" D - Provides Secondary Identification - For use in International Curbsides only : Accent Color Yellow - Pantone 123

2.0 SIGN TYPES



#	REVISION	DATE
1	Updated	07/25/17
2	Updated	10/18/17

2.3 Sign Type Index



ST - 462 Identification Sign (ALTERNATE)

South Curbsides	North Curbsides	International Curbsides
		
<ul style="list-style-type: none"> - Flag Mounted / 2 Sided / 2 Levels of Messaging - Overall dimensions: 1'- 6" H x 2'- 4-3/4" W x 7" D - Provides Secondary Identification - For use in South Curbsides only : Accent Color Red - Pantone 1795 	<ul style="list-style-type: none"> - Flag Mounted / 2 Sided / 2 Levels of Messaging - Overall dimensions: 1'- 6" H x 2'- 4-3/4" W x 7" D - Provides Secondary Identification - For use in North Curbsides only : Accent Color Blue - Pantone 2935 	<ul style="list-style-type: none"> - Flag Mounted / 2 Sided / 2 Levels of Messaging - Overall dimensions: 1'- 6" H x 2'- 4-3/4" W x 7" D - Provides Secondary Identification - For use in International Curbsides only : Accent Color Yellow - Pantone 123

ST - 464 Regulatory Sign (ALTERNATE)

South Curbsides	North Curbsides	International Curbsides
		
<ul style="list-style-type: none"> - Flag Mounted / 2 Sided / 2 Levels of Messaging - Overall dimensions: 1'- 6" H x 2'- 4-3/4" W x 7" D - Provides Regulatory Identification - For use in South Curbsides only : Accent Color Red - Pantone 1795 	<ul style="list-style-type: none"> - Flag Mounted / 2 Sided / 2 Levels of Messaging - Overall dimensions: 1'- 6" H x 2'- 4-3/4" W x 7" D - Provides Regulatory Identification - For use in North Curbsides only : Accent Color Blue - Pantone 2935 	<ul style="list-style-type: none"> - Flag Mounted / 2 Sided / 2 Levels of Messaging - Overall dimensions: 1'- 6" H x 2'- 4-3/4" W x 7" D - Provides Regulatory Identification - For use in International Curbsides only : Accent Color Yellow - Pantone 123

ST - 470 Door Identification (ALTERNATE)

South Curbsides	North Curbsides	International Curbsides
		
<ul style="list-style-type: none"> - First Surface on Glass / 1 sided - Overall dimensions: 2'- 0" Dia. - Provides Primary Identification - For use in South Curbsides only : White Acrylic 	<ul style="list-style-type: none"> - First Surface on Glass / 1 sided - Overall dimensions: 2'- 0" Dia. - Provides Primary Identification - For use in North Curbsides only : White Acrylic 	<ul style="list-style-type: none"> - First Surface on Glass / 1 sided - Overall dimensions: 2'- 0" Dia. - Provides Primary Identification - For use in International Curbsides only : White Acrylic

2.0 SIGN TYPES

#	REVISION	DATE
1	Updated	07/25/17
2	Updated	10/18/17

2.3 Sign Type Index

ST - 472 Terminal Identification

South Curbsides	North Curbsides	International Curbsides
<ul style="list-style-type: none"> - Door Identification / 1 Sided / 2 Levels of Messaging - Overall dimensions: 2'- 8" H x 2'- 8" W - Provides Terminal Identification - For use in South Curbsides only 	<ul style="list-style-type: none"> - Door Identification / 1 Sided / 2 Levels of Messaging - Overall dimensions: 2'- 8" H x 2'- 8" W - Provides Terminal Identification - For use in North Curbsides only 	<ul style="list-style-type: none"> - Door Identification / 1 Sided / 2 Levels of Messaging - Overall dimensions: 2'- 8" H x 2'- 8" W - Provides Terminal Identification - For use in International Curbsides only

ST - 474 Regulatory

South Curbsides	North Curbsides	International Curbsides
<ul style="list-style-type: none"> - First surface on glass/ 1 Sided / 3 Levels of Messaging - Overall dimensions: 4'- 0" H x 1'- 6" W - Provides Regulatory Identification - All graphic content from DOA 	<ul style="list-style-type: none"> - First surface on glass/ 1 Sided / 3 Levels of Messaging - Overall dimensions: 4'- 0" H x 1'- 6" W - Provides Regulatory Identification - All graphic content from DOA 	<ul style="list-style-type: none"> - First surface on glass/ 1 Sided / 3 Levels of Messaging - Overall dimensions: 4'- 0" H x 1'- 6" W - Provides Regulatory Identification - All graphic content from DOA

2.0 SIGN TYPES

#	REVISION	DATE
1	Updated	07/25/17
2	Updated	10/20/17

2.4 Sign Type Layouts

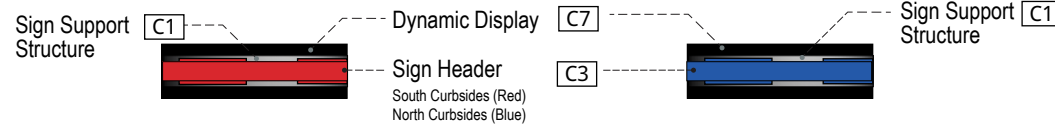

Notes:
 1. Signs with messages to South Curbsides will utilize "red" accent bar (Pantone 1795) only.
 2. Signs with directional messages to North Curbsides will utilize "blue" accent bar (Pantone 2935) only.
 3. Colors are not interchangeable, and cannot be substituted.

1 TOP VIEW FINISH
SCALE: NTS

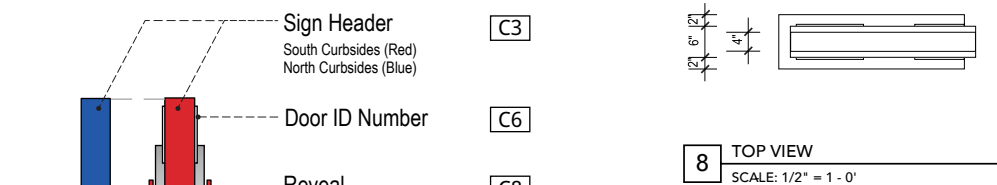

5 SIGN FINISHES - SIDE VIEW 1
SCALE: NTS

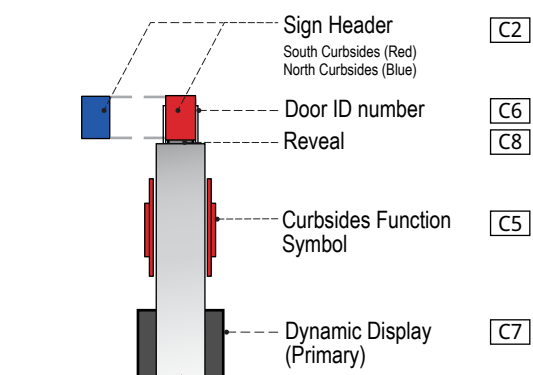

6 SIGN FINISHES - SIDE VIEW 2
SCALE: NTS

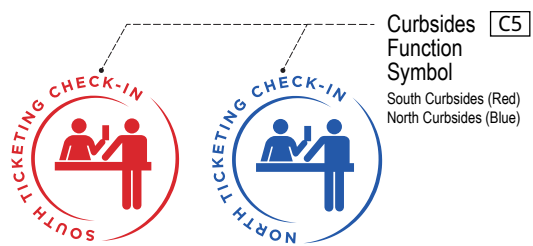

7 FUNCTION SYMBOL FINISHES
SCALE: NTS

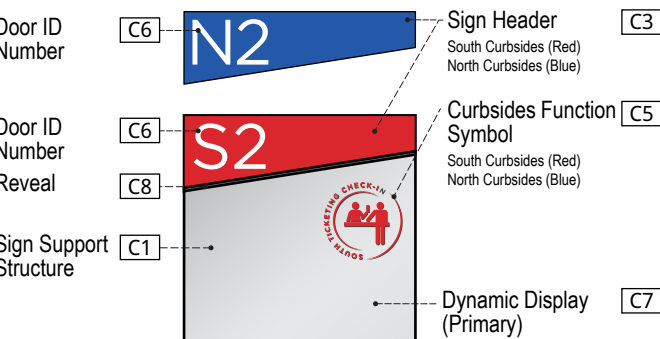

2 SIGN FINISHES
SCALE: NTS

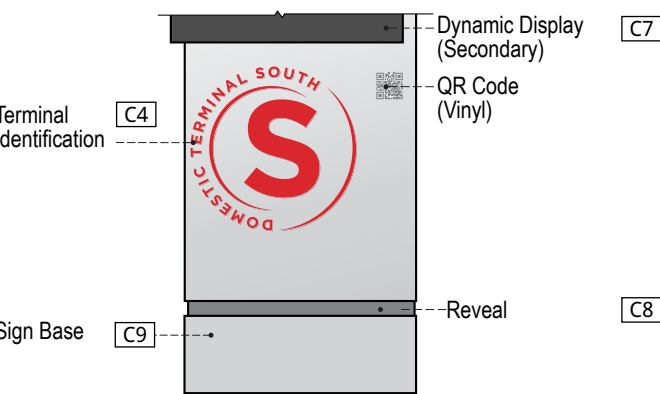

3 SIGN FINISHES
SCALE: NTS



4 ICON FINISHES
SCALE: NTS

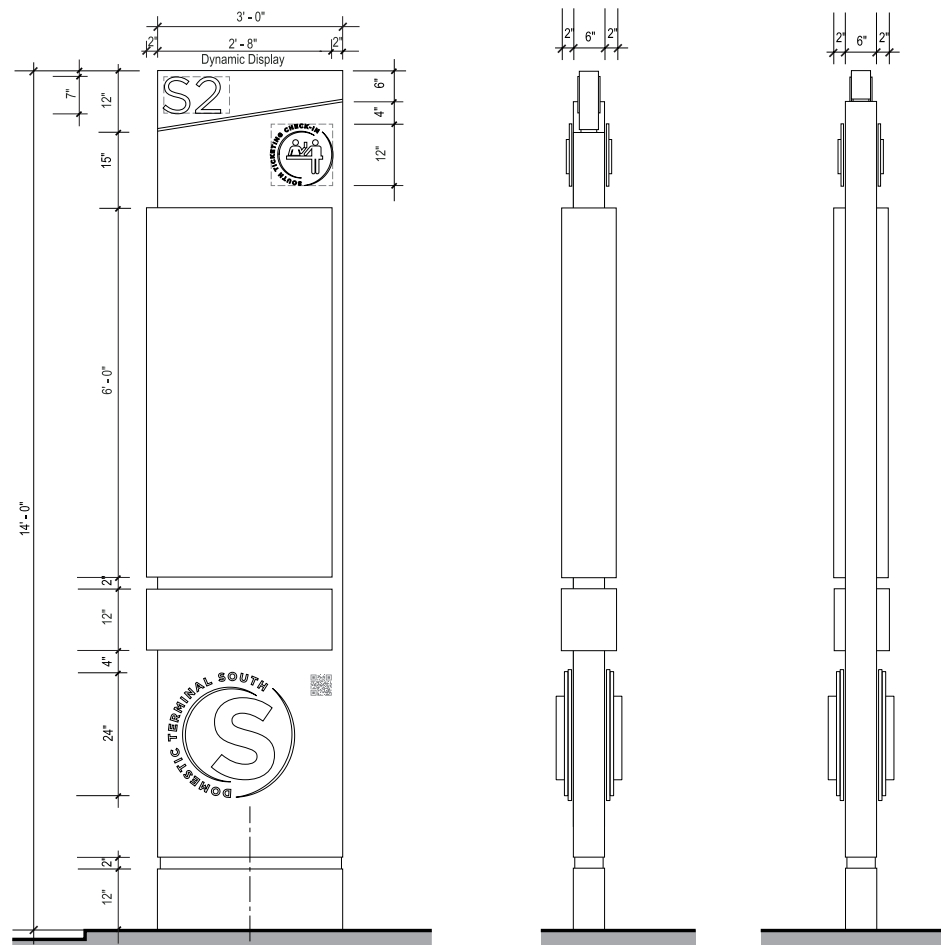

9 FACE LAYOUT
SCALE: NTS

10 SIDE VIEW 1
SCALE: NTS

11 SIDE VIEW 2
SCALE: NTS

Identification ST-400

Descriptions: Primary Identification - 2 sided
Primary / Secondary Dynamic Display

Dimensions: 14'-0" High x 3'-2" Wide x 10" Deep

Location: Upper Level Curbsides

Material: Exterior grade aluminum sign

Lettering: 1. English - Gotham Book

Symbology: Refer to Section 1 - Graphic Standards

Colors:

- C1 • Sign Support Structure
- Seamless fabricated .040 thick satin brushed aluminum
- C2 • Messages - English and Foreign Language
- Internally illuminated (White)
- C3 • Sign Header
- .125" thick seamless fabricated clear acrylic overlaid with vinyls corresponding to assigned accent colors for:
North Curbsides - Pantone 2935 (Blue)
South Curbsides - Pantone 1795 (Red)
- Internally illuminated
- C4 • Refer to Section 1- Graphics Standards Terminal Identification Logo
- 1/8" Thick machine cut dimensional acrylic letters, painted with assigned accent colors for:
North Curbsides - Pantone 2935 (Blue)
South Curbsides - Pantone 1795 (Red) mounted onto 1/2" thick x 15" dia. brushed aluminum disc.
- All returns to have painted finish to match sign face
- Internally illuminated
- C5 • Refer to Section 1- Graphics Standards Curbsides Function Symbol
- 1/8" Thick machine cut dimensional acrylic letters, painted with assigned accent colors for:
North Curbsides - Pantone 2935 (Blue)
South Curbsides - Pantone 1795 (Red) mounted onto 1/2" thick x 15" dia. brushed aluminum disc.
- All returns to have painted finish to match sign face
- LED Internally illuminated
- C6 • Door Identification Number
- Internally illuminated (White)
- C7 • Dynamic Display
- Primary and Secondary By others
- C8 • Reveal - Header and Base
- Satin brushed aluminum
- C9 • Sign Base
- Satin brushed aluminum

Graphics: N/A
Mounting: Freestanding
Illuminations: Internal
Remarks: Dynamic display messages will vary per Owner's request.

2.0 SIGN TYPES

#	REVISION	DATE
1	Updated	07/25/17
2	Updated	10/20/17

2.4 Sign Type Layouts

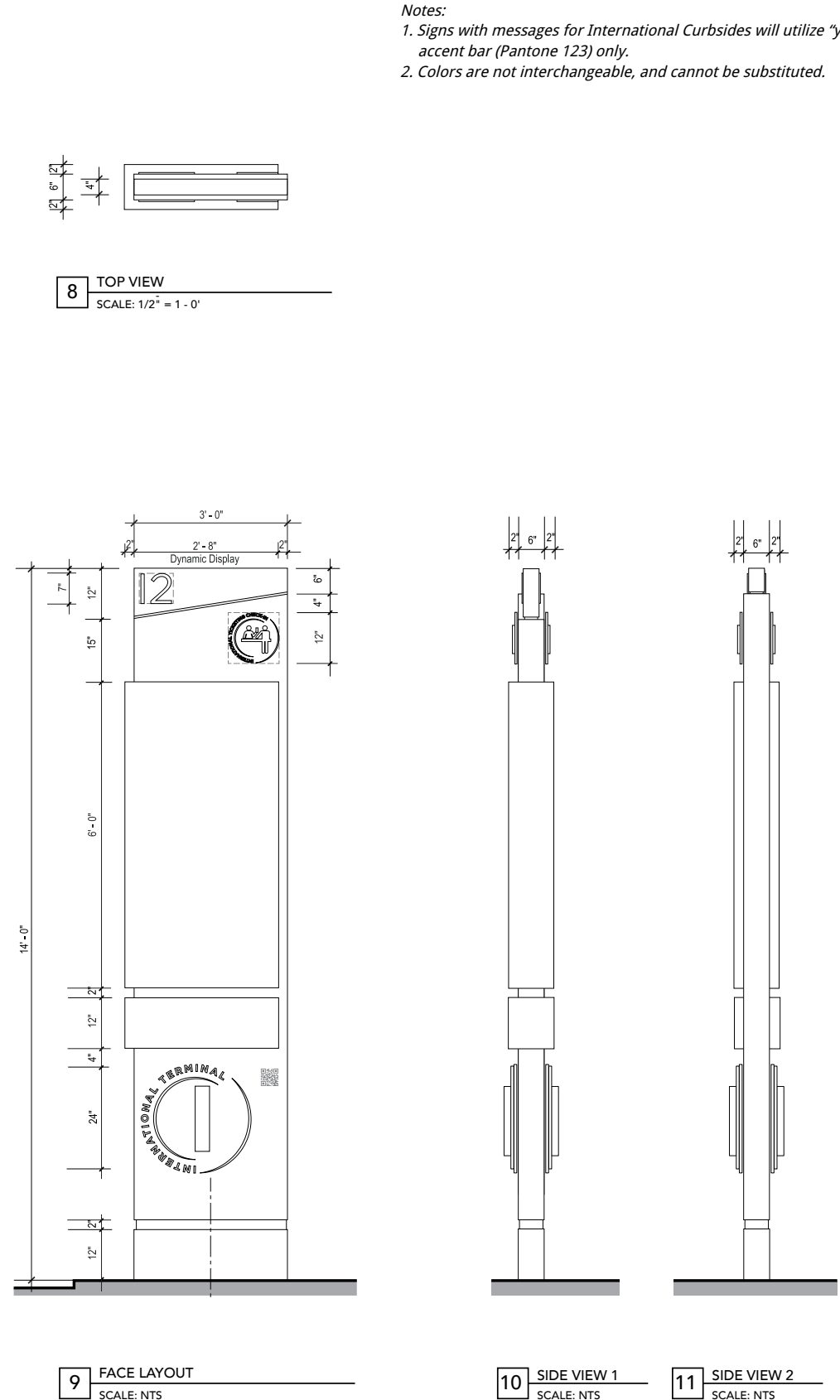
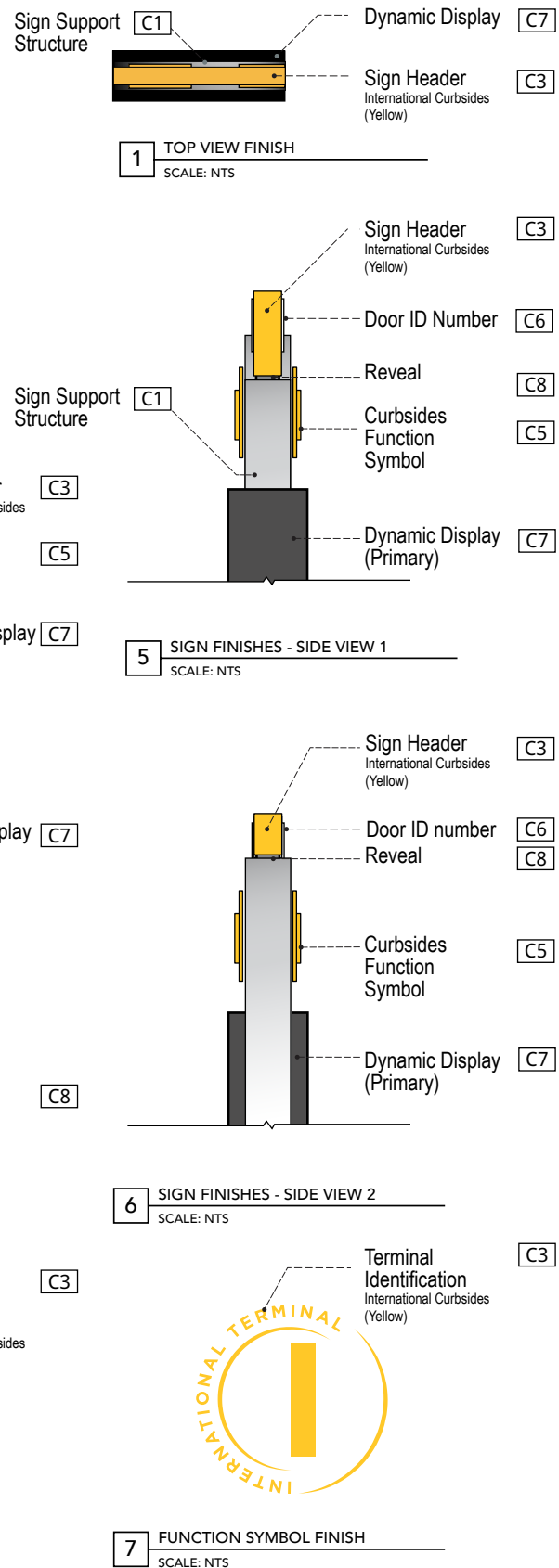
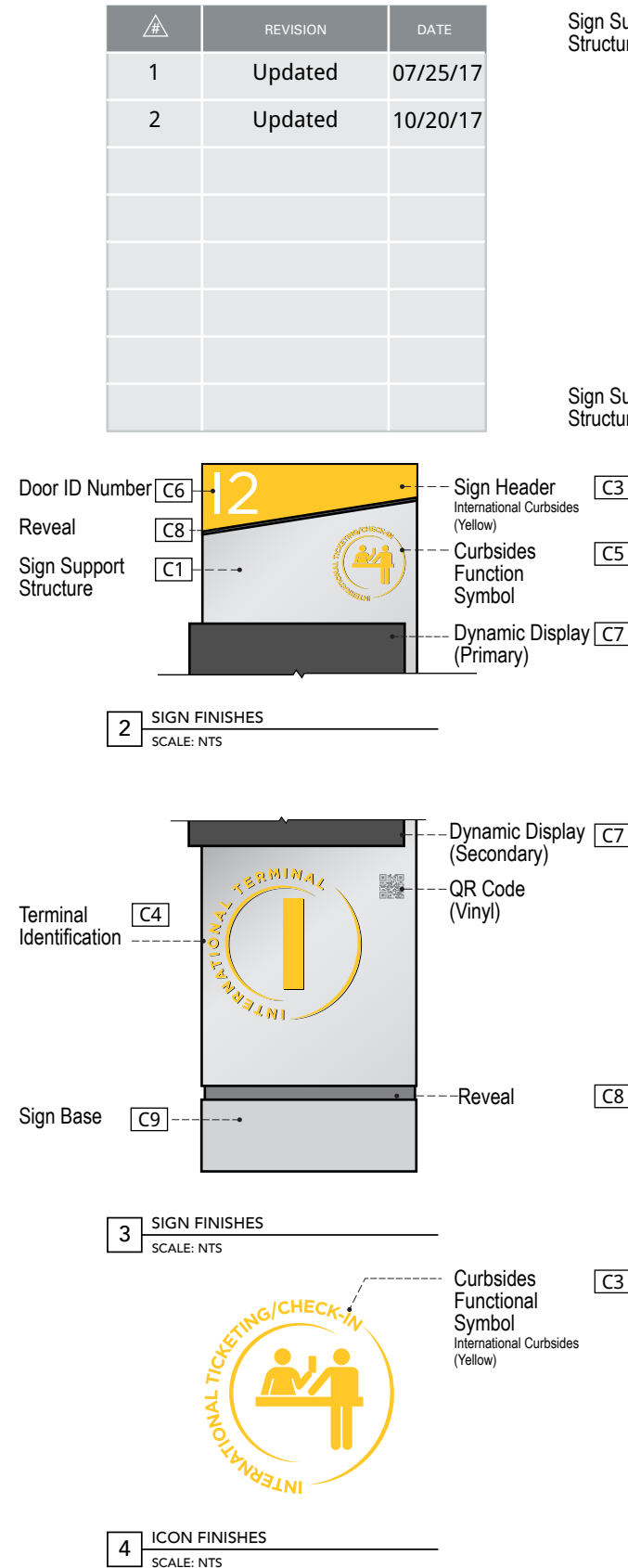

Notes:
 1. Signs with messages for International Curbsides will utilize "yellow" accent bar (Pantone 123) only.
 2. Colors are not interchangeable, and cannot be substituted.

Identification ST-400

Descriptions: Primary Identification - 2 sided
 Primary / Secondary Dynamic Display

Dimensions: 14'-0" High x 3'-2" Wide x 10" Deep

Location: Upper Level Curbsides

Material: Exterior grade aluminum sign

Lettering: 1. English - Gotham Book

Symbology: Refer to Section 1 - Graphic Standards

Colors:

- [C1] • Sign Support Structure
 - Seamless fabricated .040 thick satin brushed aluminum
- [C2] • Messages - English and Foreign Language
 - Internally illuminated (White)
- [C3] • Sign Header
 - .125" thick seamless fabricated clear acrylic overlaid with vinyls corresponding to assigned accent colors for:
 International Curbsides - Pantone 123 (Yellow)
 - Internally illuminated
- [C4] • Refer to Section 1- Graphics Standards Terminal Identification Logo
 - 1/8" Thick machine cut dimensional acrylic letters, painted with assigned accent colors for:
 International Curbsides - Pantone 123 (Yellow) mounted onto 1/2" thick x 15" dia. brushed aluminum disc.
 - All returns to have painted finish to match sign face
 - Internally illuminated
- [C5] • Refer to Section 1- Graphics Standards Curbsides Function Symbol
 - 1/8" Thick machine cut dimensional acrylic letters, painted with assigned accent colors for:
 International Curbsides - Pantone 123 (Yellow) mounted onto 1/2" thick x 15" dia. brushed aluminum disc.
 - All returns to have painted finish to match sign face
 - LED Internally illuminated
- [C6] • Door Identification Number
 - Internally illuminated (White)
- [C7] • Dynamic Display
 - Primary and Secondary By others
- [C8] • Reveal - Header and Base
 - Satin brushed aluminum
- [C9] • Sign Base
 - Satin brushed aluminum

Graphics: N/A
Mounting: Freestanding
Illuminations: Internal
Remarks: Dynamic display messages will vary per Owner's request.

2.0 SIGN TYPES

#	REVISION	DATE
1	Updated	07/25/17
2	Updated	10/20/17

2.4 Sign Type Layouts

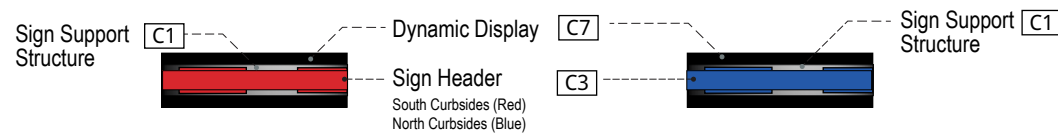

1 TOP VIEW FINISH
SCALE: NTS

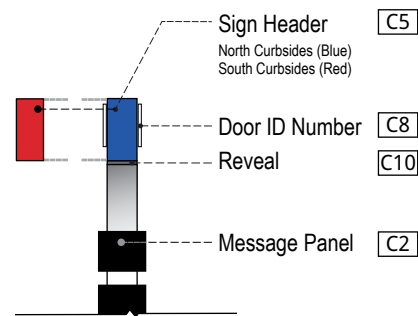

5 SIGN FINISHES - SIDE VIEW 1
SCALE: NTS

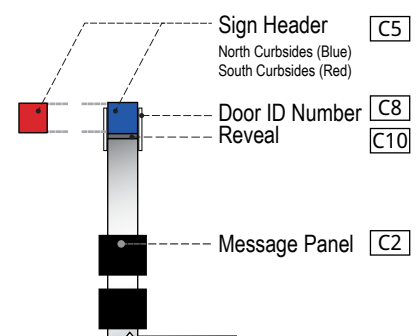

6 SIGN FINISHES - SIDE VIEW 2
SCALE: NTS

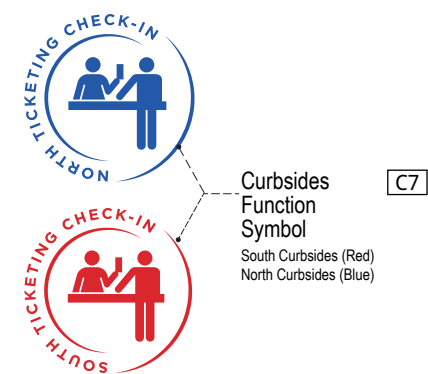

7 FUNCTIONAL SYMBOL FINISHES
SCALE: NTS

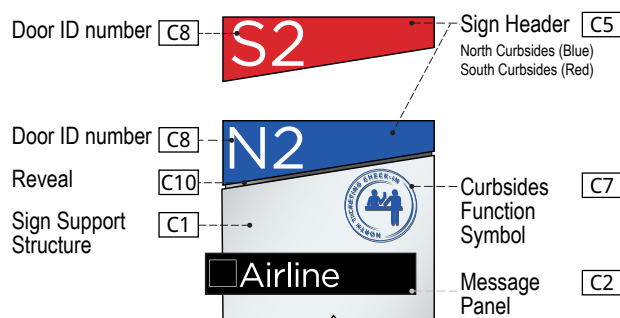

2 SIGN FINISHES
SCALE: NTS

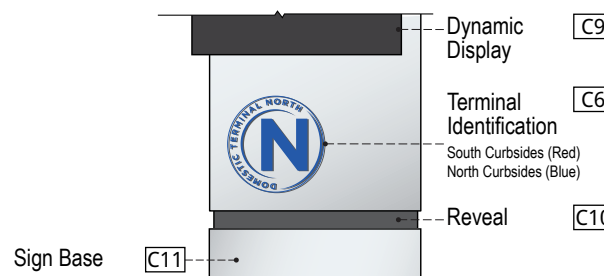

3 SIGN FINISHES
SCALE: NTS

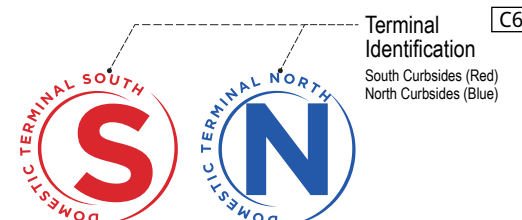

4 ICON FINISHES
SCALE: NTS

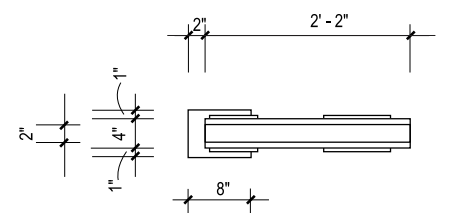

8 TOP VIEW
SCALE: 1/2" = 1'-0"

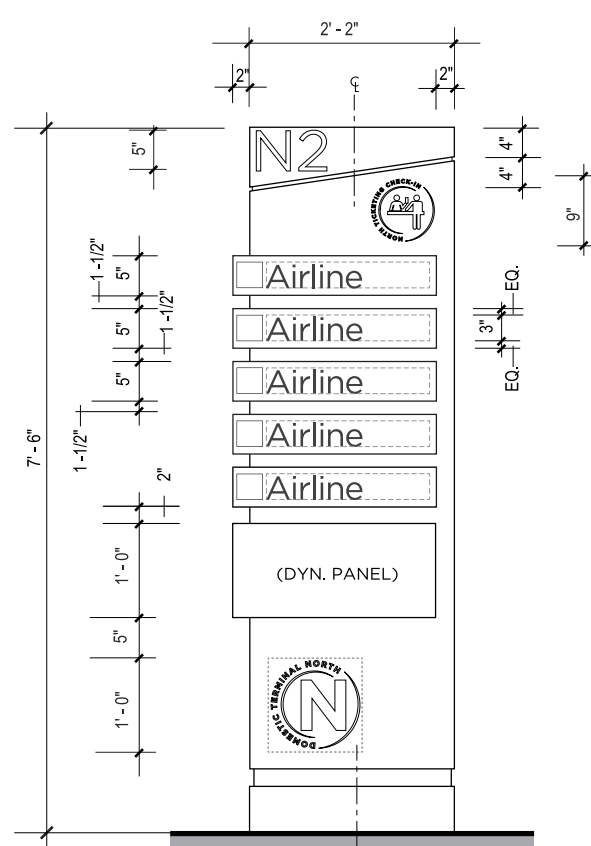

9 FACE VIEW
SCALE: NTS

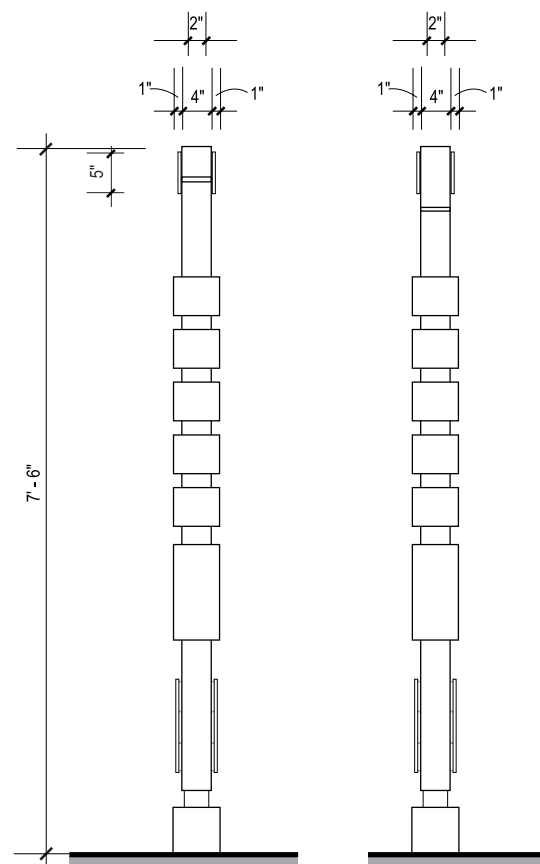

10 SIDE VIEW 1
SCALE: NTS

11 SIDE VIEW 2
SCALE: NTS

- Notes:
1. Signs with messages to South Curbsides will utilize "red" accent bar (Pantone 1795) only.
 2. Signs with directional messages to North Curbsides will utilize "blue" accent bar (Pantone 2935) only.
 3. Colors are not interchangeable, and cannot be substituted.

Colors cont'd.: [C11] • Sign Base
- Satin brushed aluminum

Graphics: N/A
Mounting: Freestanding
Illuminations: Internal
Remarks: Dynamic display messages will vary per Owner's request.

Identification ST-402

- Descriptions:** Primary Identification - Airline Listing
5 Levels of messaging / 2 sided.
- Dimensions:** 7'- 6" High x 2'- 4" Wide x 6" Deep
- Location:** Upper Level Curbsides
- Material:** Exterior grade aluminum sign with removable message panels.
- Lettering:** 1. English - Gotham Book
- Symbology:** Refer to Section 1 - Graphic Standards
- Colors:**
- [C1] • Sign Support Structure
- Seamless fabricated .040 thick satin brushed aluminum
 - [C2] • Message Panels
- .125" thick seamless fabricated clear acrylic overlaid with opaque Matte Black vinyl
- Internally illuminated
 - [C3] • Messages - English
- Internally illuminated (White)
 - [C4] • Symbols (Airlines)
- Internally illuminated (White)
 - [C5] • Sign Header
- .125" thick seamless fabricated clear acrylic overlaid with vinyls corresponding to assigned accent colors for:
North Curbsides - Pantone 2935 (Blue)
South Curbsides - Pantone 1795 (Red)
- Internally illuminated
 - [C6] • Refer to Section 1- Graphics Standards Terminal Identification Logo
- 1/8" Thick machine cut dimensional acrylic letters, painted with assigned accent colors for:
North Curbsides - Pantone 2935 (Blue)
South Curbsides - Pantone 1795 (Red) brushed aluminum disc.
- All returns to have painted finish to match sign face
- Internally illuminated
 - [C7] • Refer to Section 1- Graphics Standards Curbsides Function Symbol
- 1/8" Thick machine cut dimensional acrylic letters, painted with assigned accent colors for:
North Terminal - Pantone 2935 (Blue)
South Terminal - Pantone 1795 (Red) mounted onto 1/2" thick x 15" dia. brushed aluminum disc.
- All returns to have painted finish to match sign face
- Internally illuminated
 - [C8] • Door Identification Number
- Internally illuminated (White)
 - [C9] • Dynamic Display
- Primary and Secondary By others
 - [C10] • Reveal - Header and Base
- Satin brushed aluminum

2.0 SIGN TYPES

#	REVISION	DATE
1	Updated	07/25/17
2	Updated	10/20/17

2.4 Sign Type Layouts

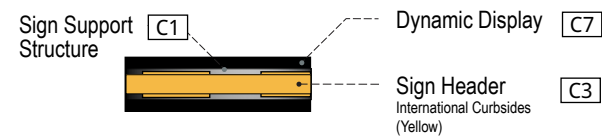

1 TOP VIEW FINISH
SCALE: NTS

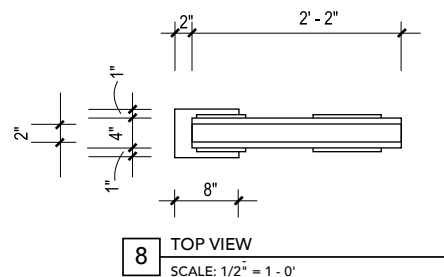

8 TOP VIEW
SCALE: 1/2" = 1'-0"

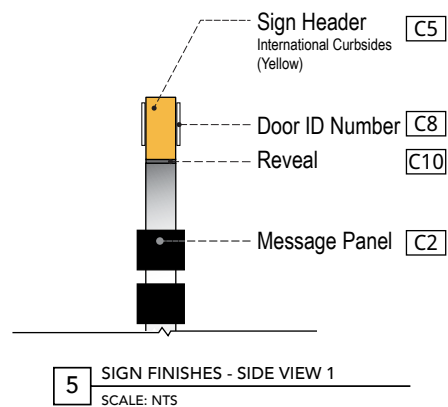

5 SIGN FINISHES - SIDE VIEW 1
SCALE: NTS

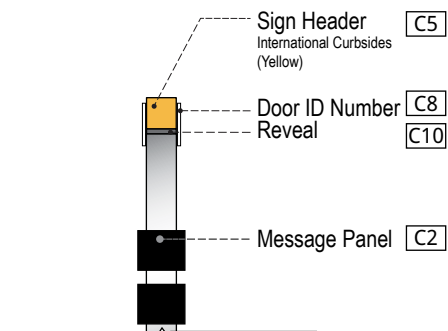

6 SIGN FINISHES - SIDE VIEW 2
SCALE: NTS

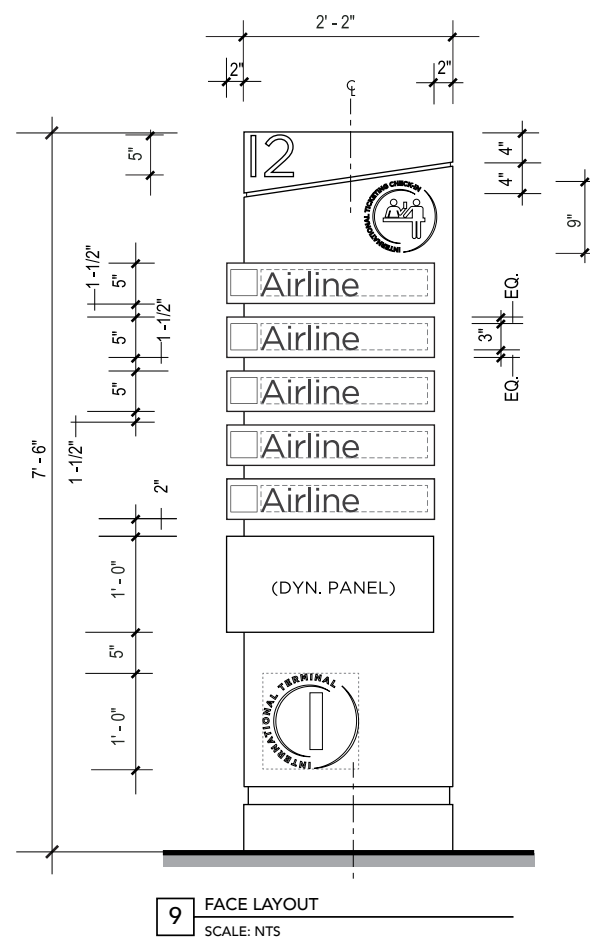

9 FACE LAYOUT
SCALE: NTS

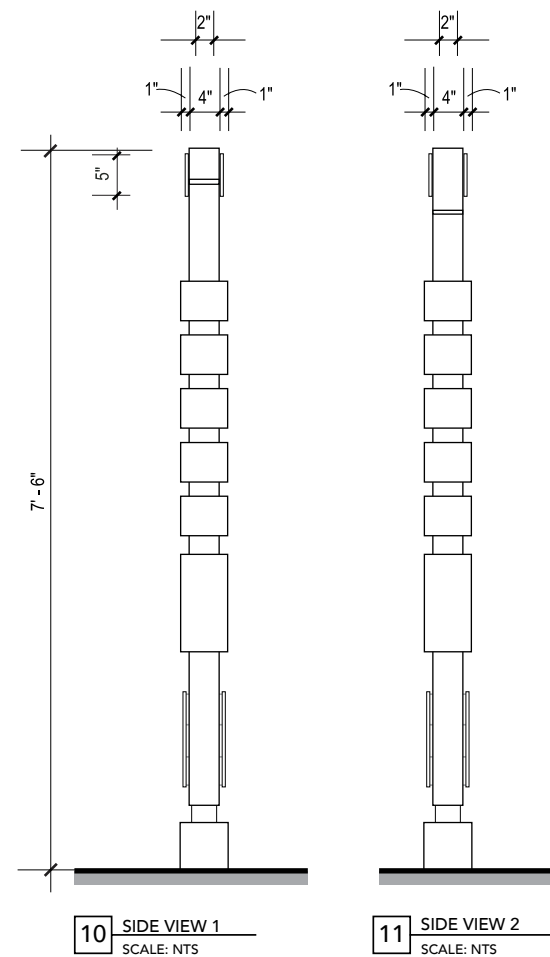

10 SIDE VIEW 1
SCALE: NTS

11 SIDE VIEW 2
SCALE: NTS

Notes:
1. Signs with messages for International Curbsides will utilize "yellow" accent bar (Pantone 123) only.
2. Colors are not interchangeable, and cannot be substituted.

Colors cont'd.: C11 • Sign Base
- Satin brushed aluminum

Graphics: N/A
Mounting: Freestanding
Illuminations: Internal
Remarks: Dynamic display messages will vary per Owner's request.

Identification **ST-402**

- Descriptions:** Primary Identification - Airline Listing
5 Levels of messaging / 2 sided.
- Dimensions:** 7'- 6" High x 2'- 4" Wide x 6" Deep
- Location:** Upper Level Curbsides
- Material:** Exterior grade aluminum sign with removable message panels.
- Lettering:** 1. English - Gotham Book
- Symbology:** Refer to Section 1 - Graphic Standards
- Colors:**
- C1 • Sign Support Structure
- Seamless fabricated .040 thick satin brushed aluminum
 - C2 • Message Panels
- .125" thick seamless fabricated exterior sign grade translucent polycarbonate overlaid with opaque Matte Black vinyl
- Internally illuminated
 - C3 • Messages - English
- Internally illuminated (White)
 - C4 • Symbols (Airlines)
- Internally illuminated (White)
 - C5 • Sign Header
- .125" thick seamless fabricated clear acrylic overlaid with vinyls corresponding to assigned accent colors for:
International Curbsides - Pantone 123 (Yellow)
- Internally illuminated
 - C6 • Refer to Section 1- Graphics Standards Terminal Identification Logo
- 1/8" Thick machine cut dimensional acrylic letters, painted with assigned accent colors for:
International Curbsides - Pantone 123 (Yellow) mounted onto 1/2" thick x 15" dia. brushed aluminum disc.
- All returns to have painted finish to match sign face
- Internally illuminated
 - C7 • Refer to Section 1- Graphics Standards Curbsides Function Symbol
- 1/8" Thick machine cut dimensional acrylic letters, painted with assigned accent colors for:
International Curbsides - Pantone 123 (Yellow) mounted onto 1/2" thick x 15" dia. brushed aluminum disc.
- All returns to have painted finish to match sign face
- Internally illuminated
 - C8 • Door Identification Number
- Internally illuminated (White)
 - C9 • Dynamic Display
- Primary and Secondary By others
 - C10 • Reveal - Header and Base
- Satin brushed aluminum

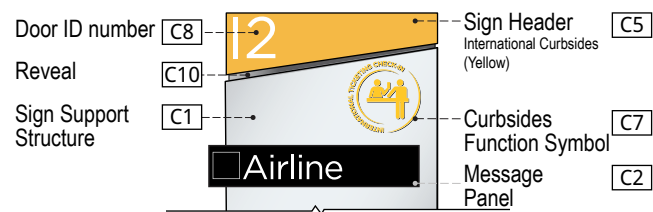

2 SIGN FINISHES
SCALE: NTS

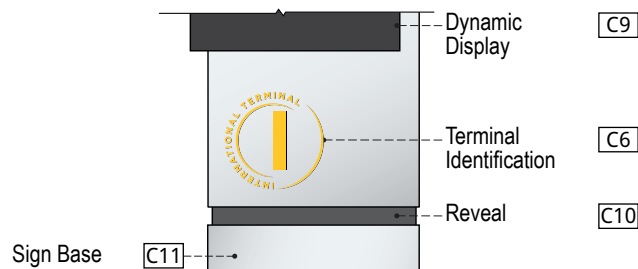

3 SIGN FINISHES
SCALE: NTS

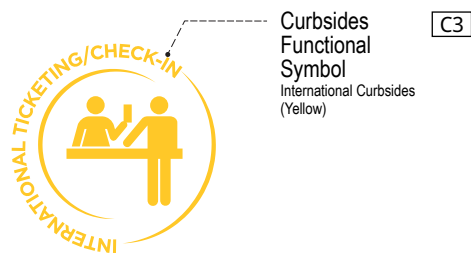

4 ICON FINISHES
SCALE: NTS

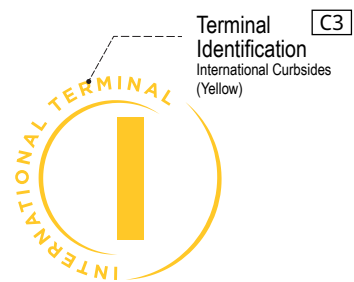

7 FUNCTION SYMBOL FINISH
SCALE: NTS

2.0 SIGN TYPES

#	REVISION	DATE
1	Updated	07/25/17
2	Updated	10/20/17

2.4 Sign Type Layouts

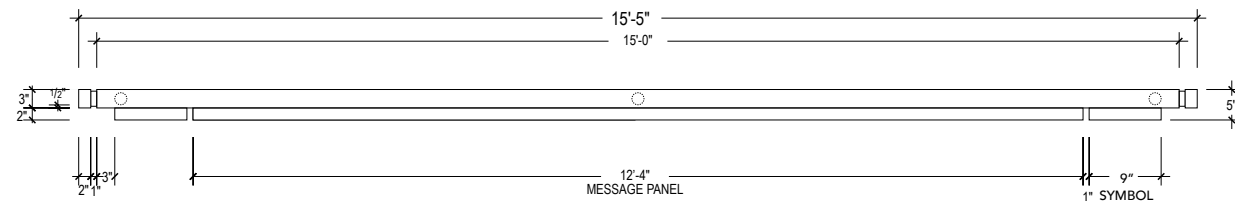

1 TOP VIEW
SCALE: 1/2" = 1' - 0"



2 FRONT VIEW
SCALE: 1/2" = 1' - 0"

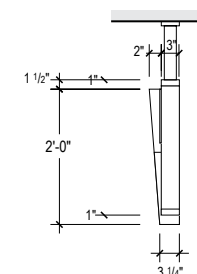

5 SIDE VIEW
SCALE: 1/2" = 1' - 0"

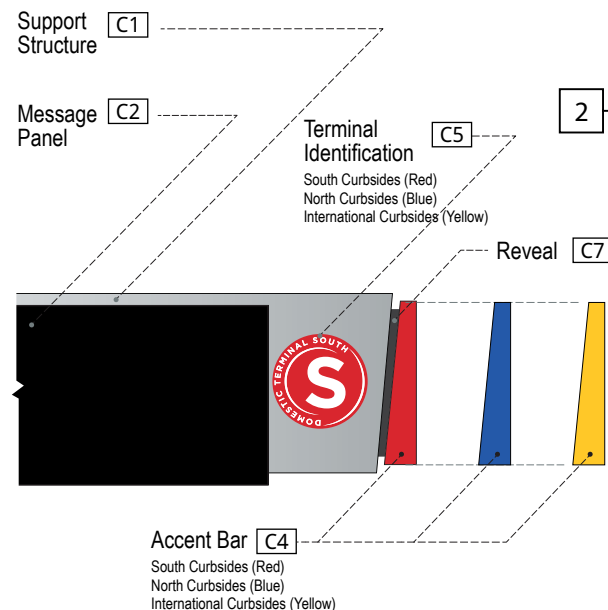

3 SIGN FINISHES
SCALE: NTS

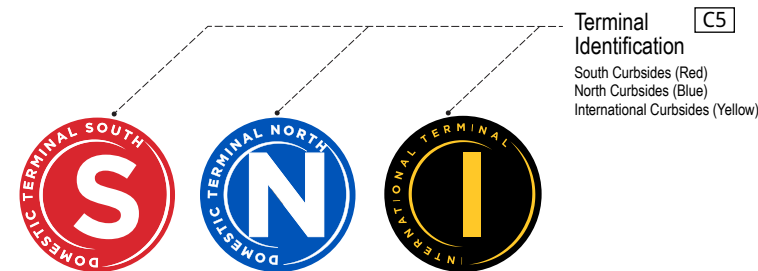

4 ICON FINISHES
SCALE: NTS

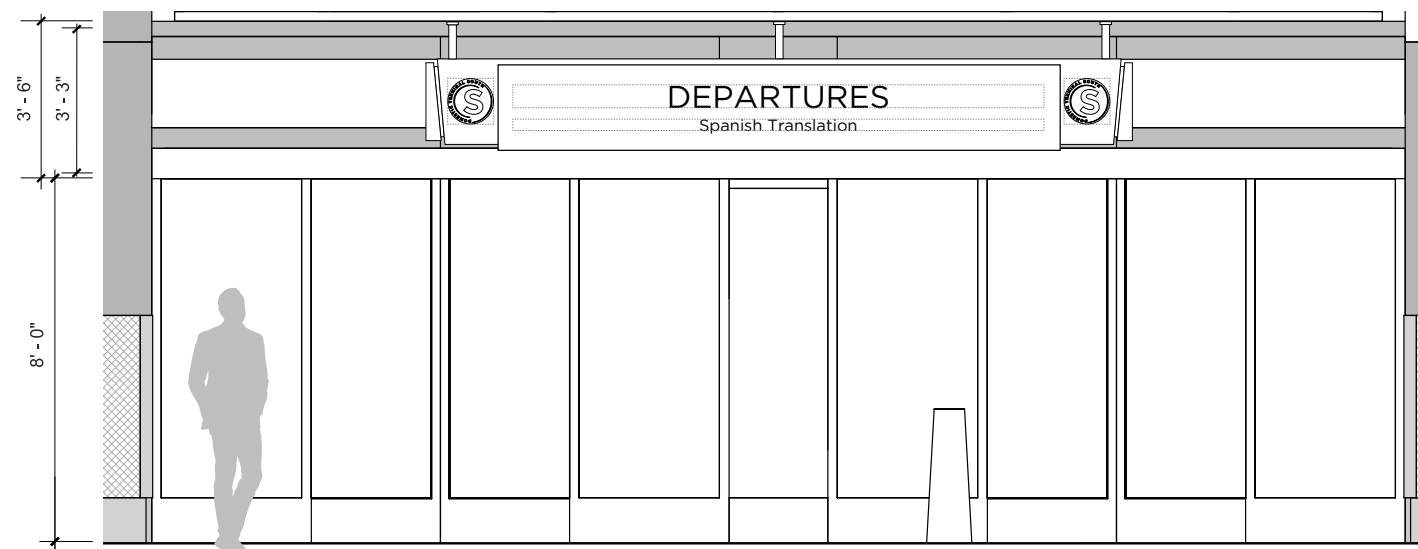

4 ELEVATION
SCALE: 1/4" = 1' - 0"

Identification ST-404

- Descriptions:** Primary Identification (ALTERNATE)
1 Level of messaging / 1 sided.
- Dimensions:** 2'- 0" High x 15'-5" Wide x 5 - 1/2" Deep
- Location:** Upper Level Curbsides Entrance
- Material:** Exterior grade aluminum sign with removable message panels.
- Lettering:**
1. English - Gotham Medium - 6" Cap height
2. Spanish - Gotham Medium - 3" Cap height
- Symbology:** N/A
- Colors:**
- [C1] Sign Support Structure
 - Seamless fabricated .040 thick satin brushed aluminum. No exposed fasteners
 - [C2] Message Panel
 - .125" thick seamless fabricated white acrylic overlaid with opaque Matte Black vinyl with reverse cut copy. Applied opaque black vinyl to sides and bottom returns.
 - Top return uncovered to create a glow on sign cabinet
 - Internally illuminated
 - [C3] Messages - English - Foreign language
 - Internally illuminated (White)
 - [C4] Accent Bars
 - .125" thick seamless fabricated exterior sign grade translucent polycarbonate overlaid with assigned accent colors for:
 - North Curbsides - Pantone 2935 (Blue)
 - South Curbsides - Pantone 1795 (Red)
 - International Curbsides - Pantone 123 (Yellow)
 - Internally illuminated
 - [C5] Terminal Identification Logo
 - 1/2" deep cast resin dimensional disk painted silver. Copy to be raised 1/8".
 - [C6] Mounting Support
 - Satin brushed square aluminum sleeve to cover attachment rod. Field verify length of attachment rod and sleeve as needed per location
 - [C7] Reveal
 - Satin brushed aluminum

Graphics: N/A
Mounting: Ceiling Suspended
Illuminations: Internal
Remarks: N/A

- Notes:**
- Signs with messages to South Curbsides will utilize "red" accent bar (Pantone 1795) only.
 - Signs with directional messages to North Curbsides will utilize "blue" accent bar (Pantone 2935) only.
 - Signs with messages for International Curbsides will utilize "yellow" accent bar (Pantone 123) only.
 - Colors are not interchangeable, and cannot be substituted.

2.0 SIGN TYPES

#	REVISION	DATE
1	Updated	07/25/17
2	Updated	10/20/17

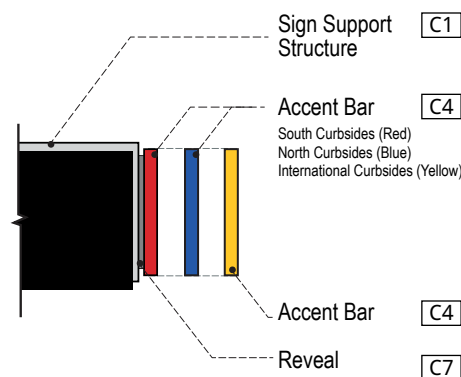

2 SIGN FINISHES
SCALE: NTS

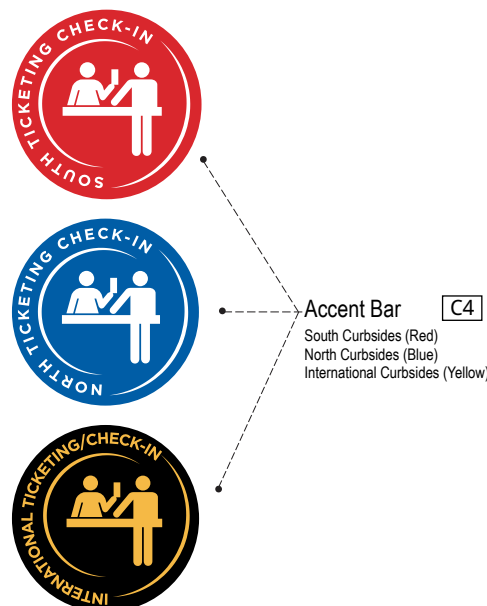

3 SIGN FINISHES
SCALE: NTS

2.4 Sign Type Layouts

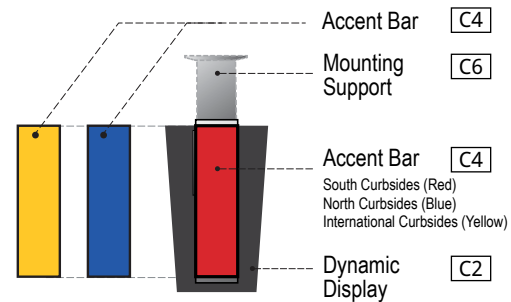

1 SIGN FINISHES
SCALE: NTS

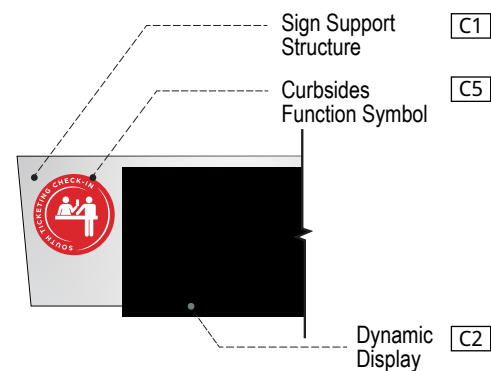

4 SIGN FINISHES
SCALE: NTS

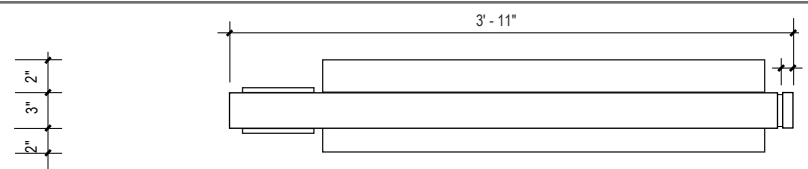

6 TOP VIEW
SCALE: 1" = 1'-0"

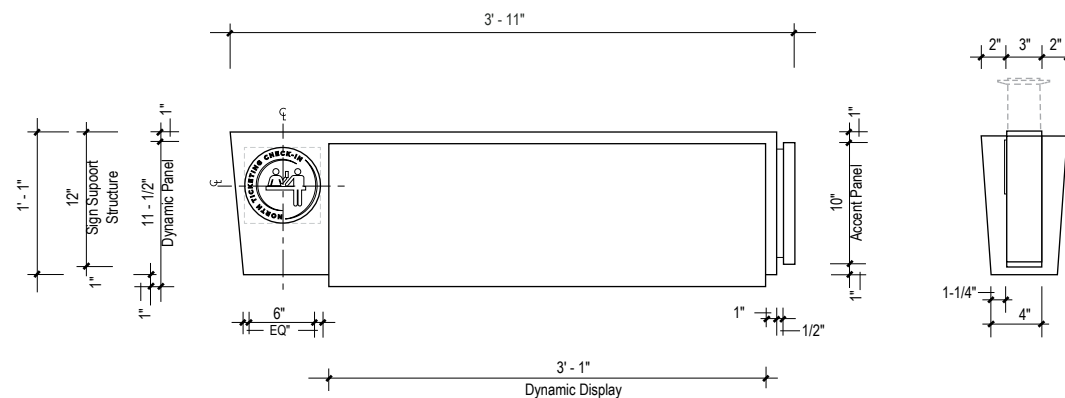

7 FRONT VIEW
SCALE: 1" = 1'-0"

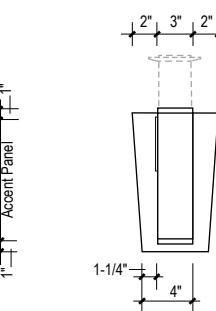

9 SIDE VIEW
SCALE: 1" = 1'-0"

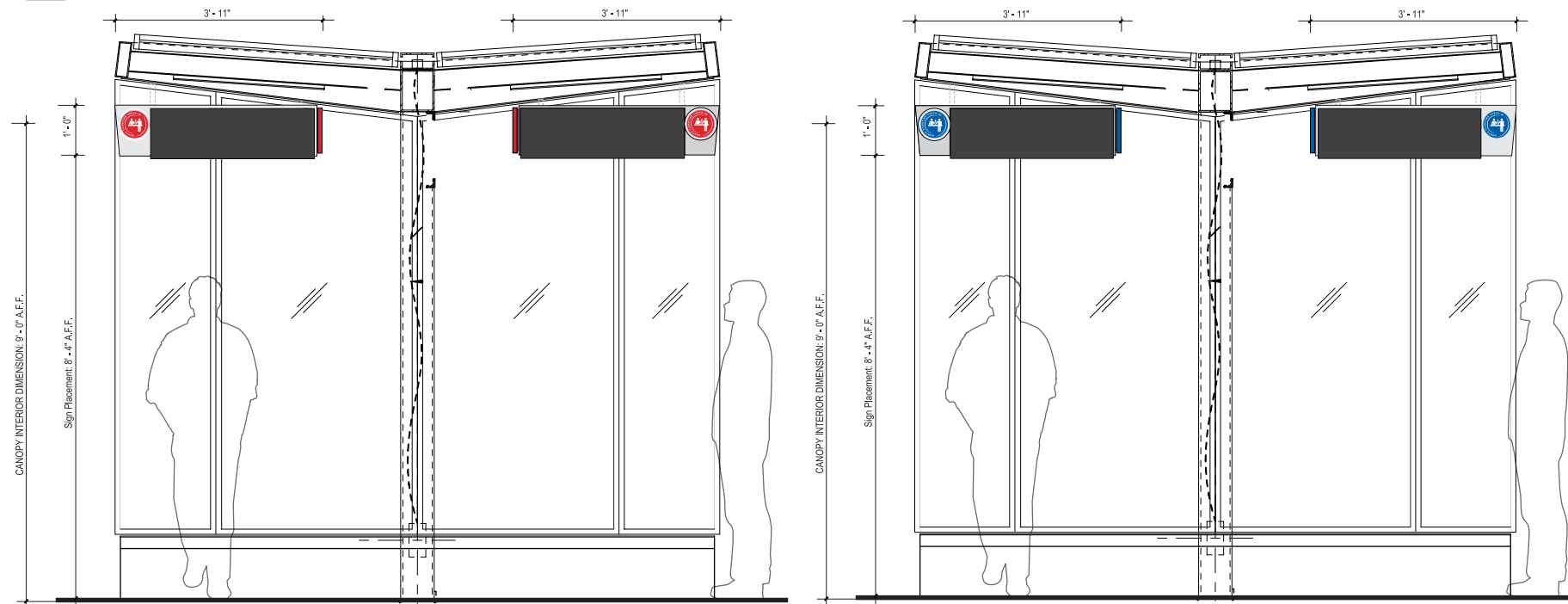

5 ELEVATION
SCALE: 1/2" = 1'-0"

8 ELEVATION
SCALE: 1/2" = 1'-0"

Identification ST-416

- Descriptions:** Primary Identification (Dynamic)
1 Level of messaging / 1 sided.
- Dimensions:** 3'- 11" High x 11'-1/2" Wide x 7" Deep
- Location:** Upper Level Curbsides Check-Ins / Canopies
- Material:** Exterior grade aluminum sign panel with removable message panels.
- Lettering:** 1. English - Gotham Medium - 6" Cap height
2. Spanish - Gotham Medium - 3" Cap height
- Symbology:** Refer to Section 1 - Graphic Standards
- Colors:**
- C1** Sign Support Structure
- Seamless fabricated .040 thick satin brushed aluminum. No exposed fasteners
 - C2** Dynamic Display
- .125" thick seamless fabricated exterior sign grade translucent polycarbonate overlaid with opaque Matte Black vinyl
 - C3** Messages - English - Foreign language
 - C4** Accent Bars
- .125" thick seamless fabricated exterior sign grade translucent polycarbonate overlaid with opaque Matte Black vinyl
- Accent Bar colors:
- North Curbsides - Pantone 2935 (Blue)
- South Curbsides - Pantone 1795 (Red)
- International Curbsides - Pantone 123 (Yellow)
- Internally illuminated
 - C5** Curbsides Function Symbol
- 1/2" deep cast resin dimensional disk painted silver. Copy to be raised 1/8".
 - C6** Mounting Support
- Satin brushed square aluminum sleeve to cover attachment support. Field verify length of attachment support and sleeve as needed per location
 - C7** Reveal
- Satin brushed aluminum
- Graphics:** N/A
Mounting: Ceiling Suspended
Illuminations: Internal
Remarks: N/A

- Notes:**
- Signs with messages to South Curbsides will utilize "red" accent bar (Pantone 1795) only.
 - Signs with directional messages to North Curbsides will utilize "blue" accent bar (Pantone 2935) only.
 - Signs with messages for International Curbsides will utilize "yellow" accent bar (Pantone 123) only.
 - Colors are not interchangeable, and cannot be substituted.

2.0 SIGN TYPES

#	REVISION	DATE
1	Updated	07/25/17
2	Updated	10/20/17

2.4 Sign Type Layouts

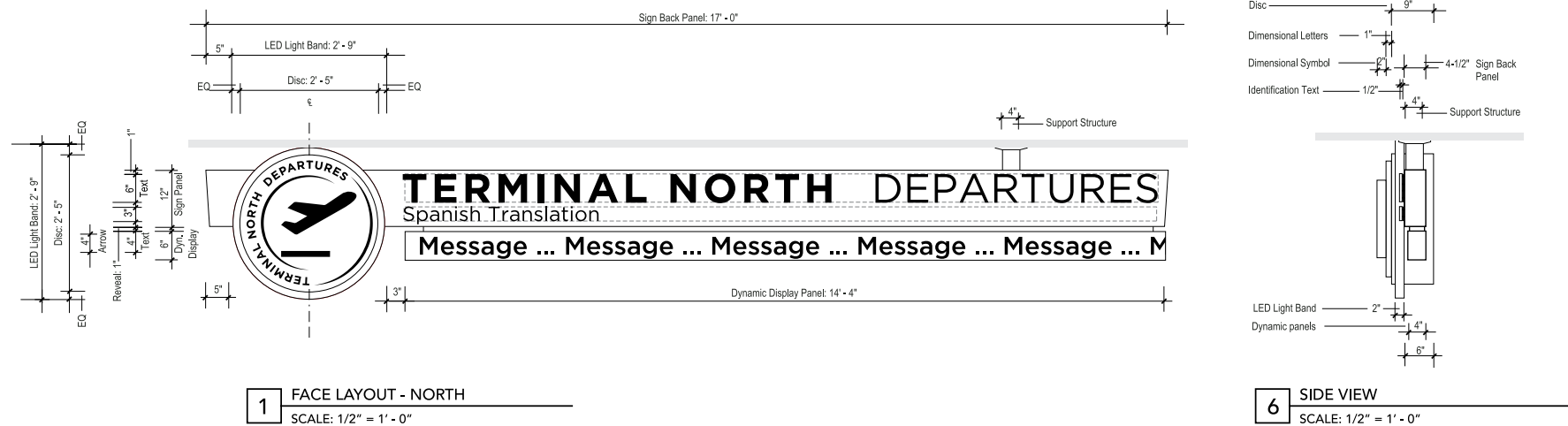

1 FACE LAYOUT - NORTH
SCALE: 1/2" = 1' - 0"

6 SIDE VIEW
SCALE: 1/2" = 1' - 0"

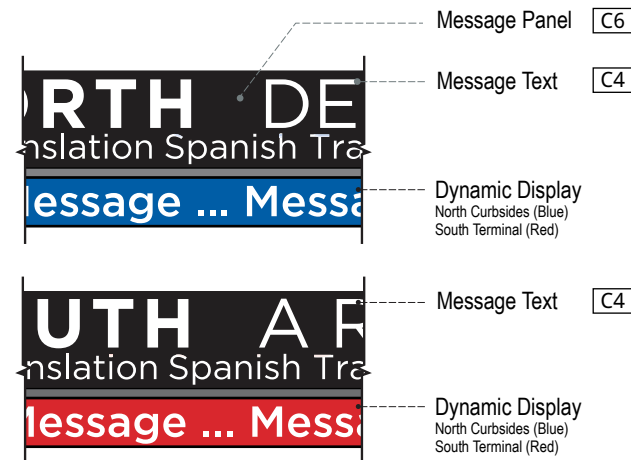

2 SIGN FINISHES
SCALE: NTS

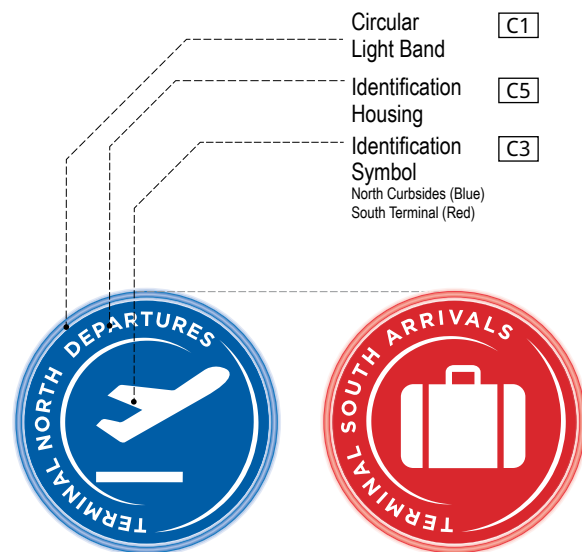

3 FINISHES - ICON
SCALE: NTS



4 FACE LAYOUT - SOUTH
SCALE: 1/2" = 1' - 0"

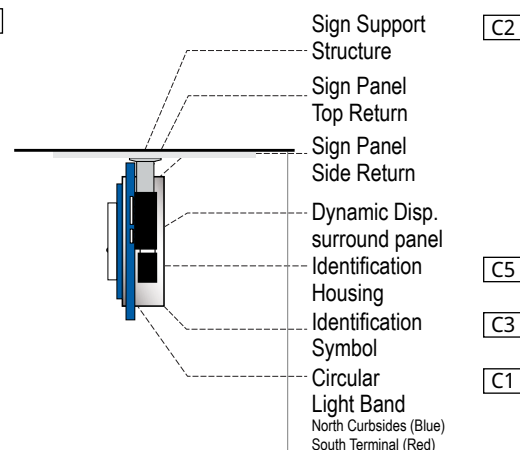

5 SIGN FINISHES - END VIEW
SCALE: NTS

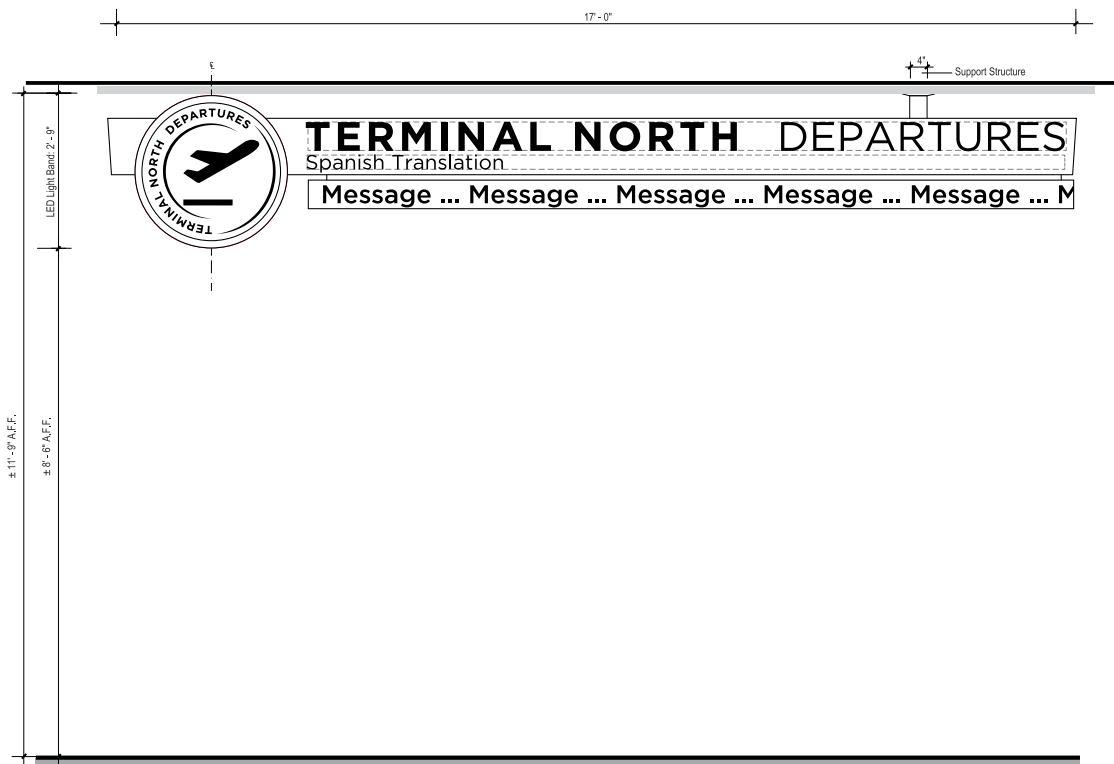

7 ELEVATION
SCALE: 1/2" = 1' - 0"

Identification **ST-442**

- Descriptions:** Primary Identification - Ceiling Mounted
- Dimensions:** 2' - 9" High x 17' - 0" Wide x 9" Deep
Dynamic Display Bar: 6" H x 14' - 4" W x 4" D
- Location:** Upper Level Curbsides Entrance
- Material:** Exterior grade aluminum sign panel
- Lettering:** Gotham Book and Medium
- Symbology:** Refer to Section 1 - Graphics Standards.
- Colors:**
- [C1] • Circular Light Band
 - 2" WHITE ACRYLIC : Translucent Exterior Sign Grade Polycarbonate
 - LED Internally illuminated.
 - [C2] • Sign Support Structure
 - Seamless fabricated .125" ALUMINUM with all edges welded, grounded and sanded to a smooth finish.
 - [C3] • Identification Symbol
 - Fabricated dimensional letters White acrylic (Exterior Sign Grade Translucent Polycarbonate)
 - LED Internally illuminated.
 - [C4] • Messages - English / Foreign Language
 - Fabricated dimensional letters White acrylic (Exterior Sign Grade Translucent Polycarbonate)
 - LED Internally illuminated.
 - [C5] • Identification Housing
 - Seamless fabricated .125" ALUMINUM (satin brushed) with all edges welded, grounded and sanded to a smooth finish.
 - [C6] • Message Panel
 - .25" fabricated clear acrylic overlaid with Matte Black vinyl.
 - [C7] • Reveal
 - ALUMINUM : Satin brushed
 - [C8] • Dynamic Display
 - North Curbsides - Pantone 2935 (Blue)
 - South Curbsides - Pantone 1795 (Red)

Graphics: N/A
Mounting: Ceiling Mounted
Illuminations: Internal
Remarks: N/A

Notes:

- Signs with messages to South Curbsides will utilize "red" accent bar (Pantone 1795) only.
- Signs with directional messages to North Curbsides will utilize "blue" accent bar (Pantone 2935) only.
- Colors are not interchangeable, and cannot be substituted.

2.0 SIGN TYPES

#	REVISION	DATE
1	Updated	07/25/17
2	Updated	10/20/17

2.4 Sign Type Layouts

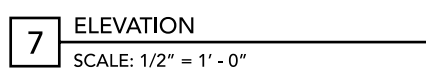
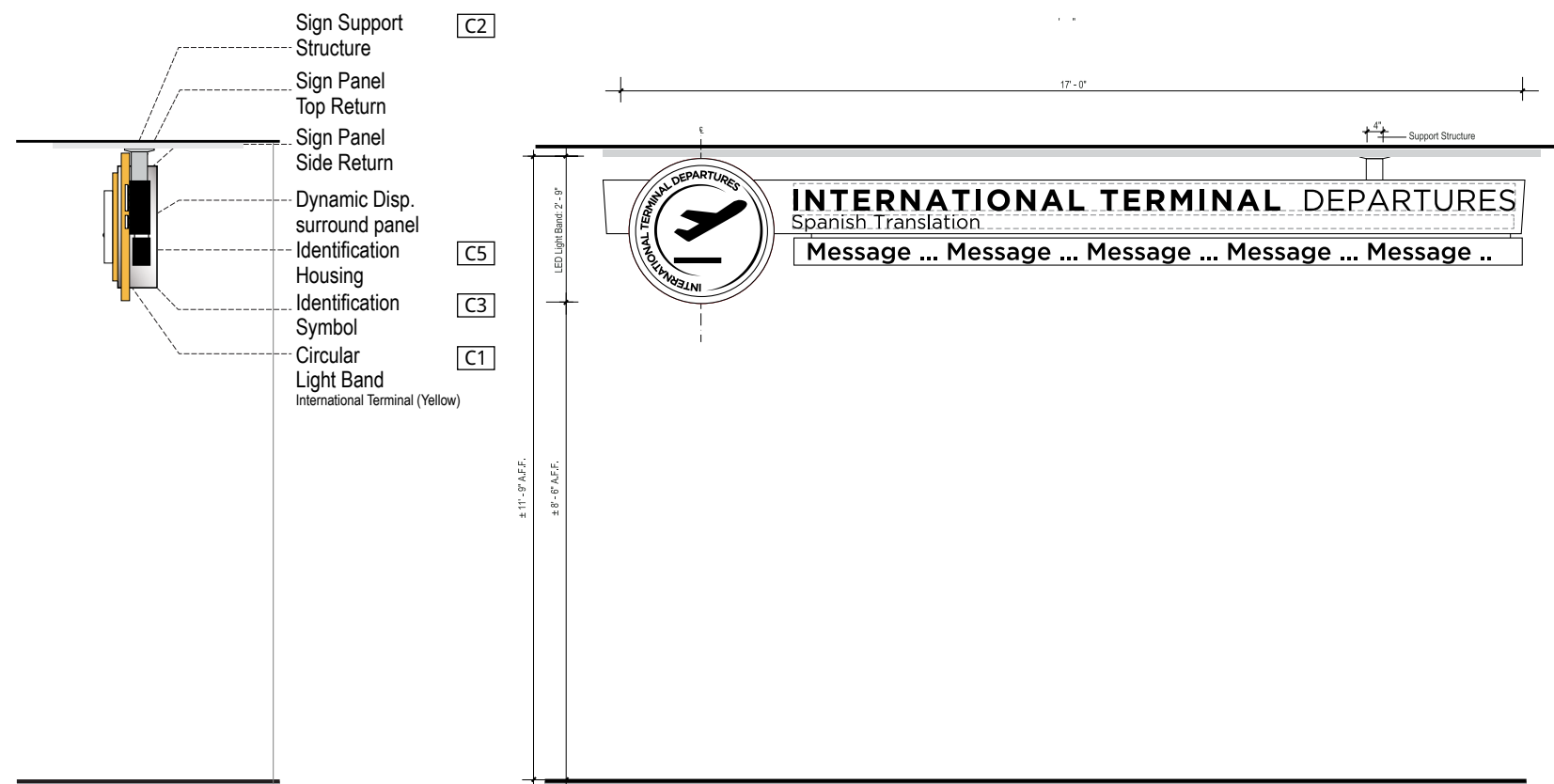
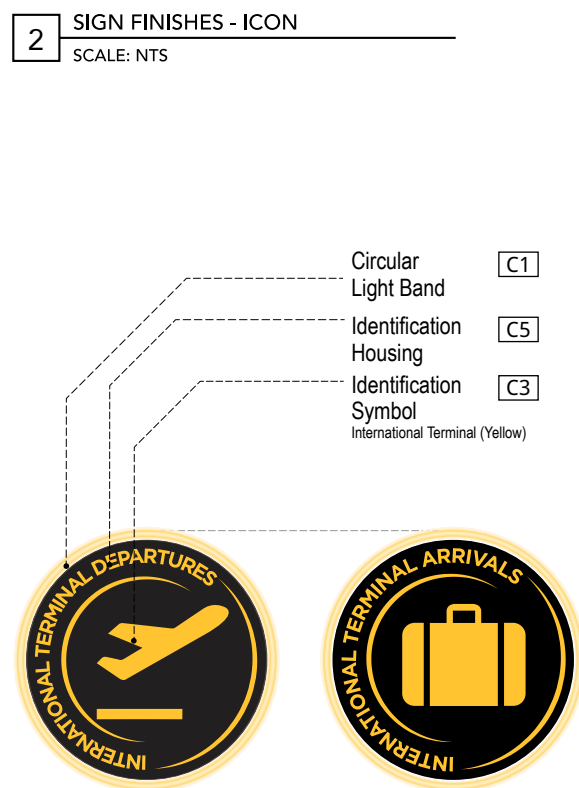
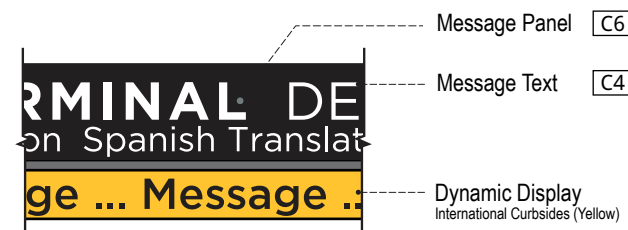
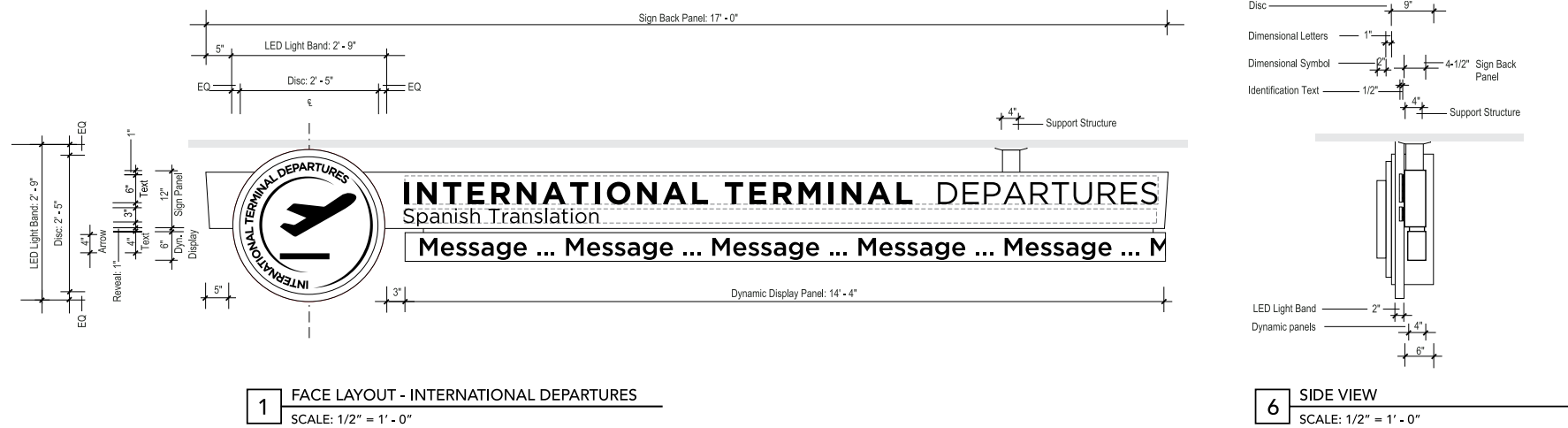

Identification **ST-442**

- Descriptions:** Primary Identification - Ceiling Mounted
- Dimensions:** 2' - 9" High x 17' - 0" Wide x 9" Deep
Dynamic Display Bar: 6" H x 14' - 4" W x 4" D
- Location:** Upper Level Curbsides Entrance
- Material:** Exterior grade aluminum sign panel
- Lettering:** Gotham Book and Medium
- Symbology:** Refer to Section 1 - Graphics Standards.
- Colors:**
- [C1] • Circular Light Band
 - 2" WHITE ACRYLIC : Translucent Exterior Sign Grade Polycarbonate
 - LED Internally illuminated.
 - [C2] • Sign Support Structure
 - Seamless fabricated .125" ALUMINUM with all edges welded, grounded and sanded to a smooth finish.
 - [C3] • Identification Symbol
 - Fabricated dimensional letters White acrylic (Exterior Sign Grade Translucent Polycarbonate)
 - LED Internally illuminated.
 - [C4] • Message Text
 - Fabricated dimensional letters White acrylic (Translucent Exterior Sign Grade Polycarbonate)
 - LED Internally illuminated.
 - [C5] • Identification Housing
 - Seamless fabricated .125" ALUMINUM (satin brushed) with all edges welded, grounded and sanded to a smooth finish.
 - [C6] • Message Panel
 - .25" fabricated clear acrylic (Exterior Sign Grade Translucent Polycarbonate) overlaid matte Black vinyl.
 - [C7] • Reveal
 - ALUMINUM : Satin brushed
 - [C8] • Dynamic Display
 - International Curbsides - Pantone 123 (Yellow)
- Graphics:** N/A
Mounting: Ceiling Mounted
Illuminations: Internal
Remarks: N/A

Notes:

1. Signs with messages for International Curbsides will utilize "yellow" accent bar (Pantone 123) only.
2. Colors are not interchangeable, and cannot be substituted.

2.0 SIGN TYPES

#	REVISION	DATE
1	Updated	07/25/17
2	Updated	10/20/17

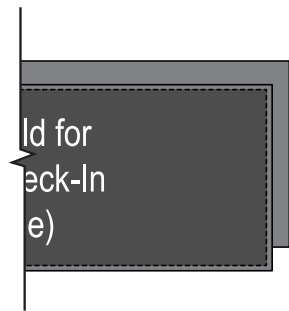

2 FRONT VIEW - FINISH
SCALE: NTS

2.4 Sign Type Layouts

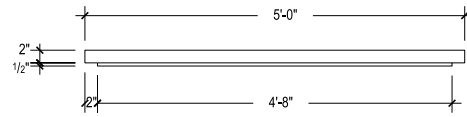

1 TOP VIEW
SCALE: 1/2" = 1' - 0"

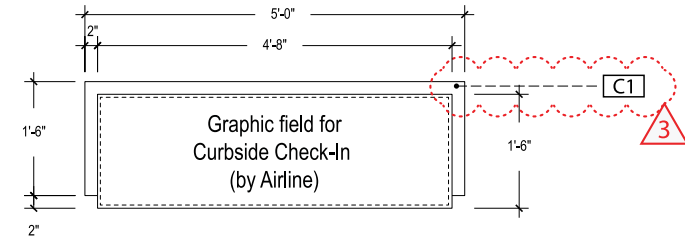

3 FRONT VIEW
SCALE: 1/2" = 1' - 0"

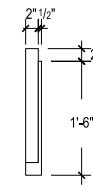

5 SIDE VIEW
SCALE: 1/2" = 1' - 0"

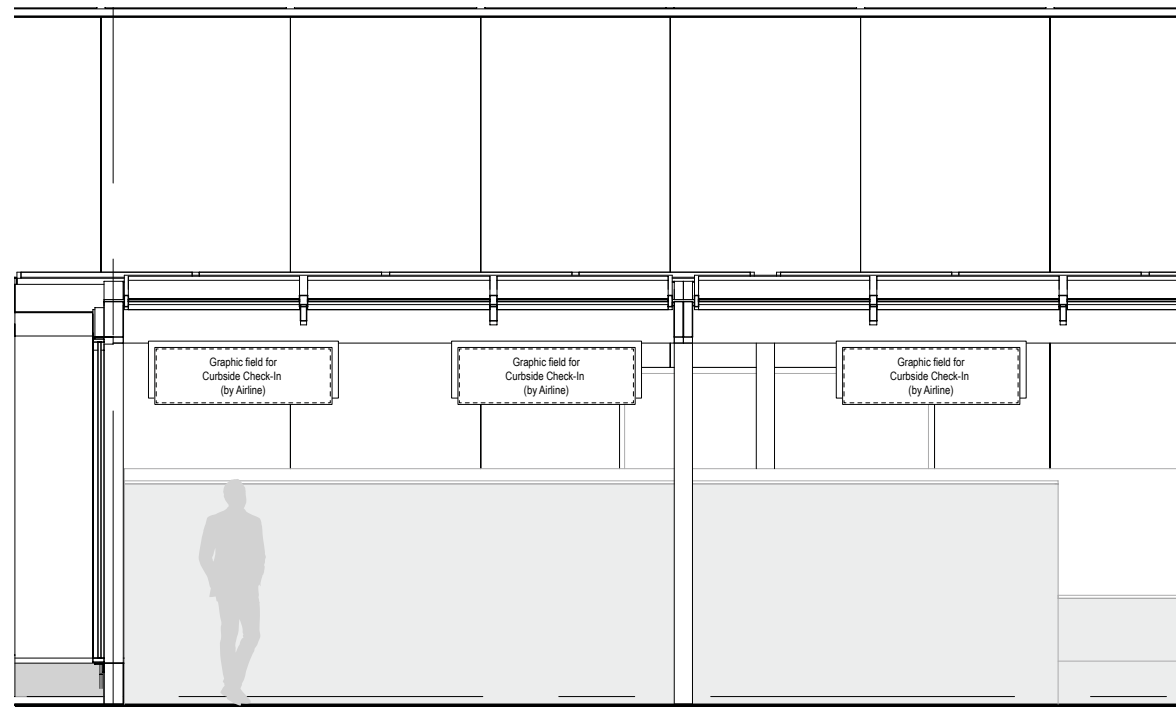

4 ELEVATION
SCALE: 1/4" = 1' - 0"

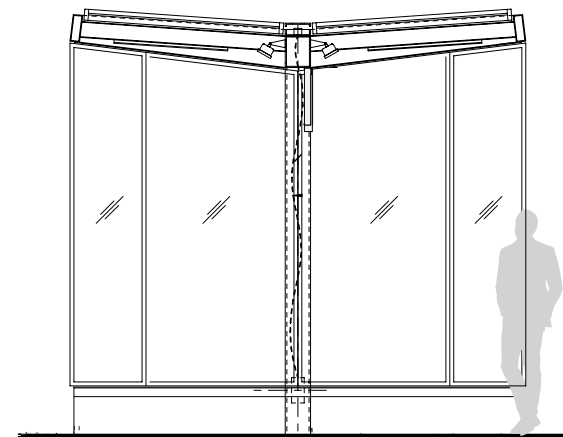

6 SIDE ELEVATION
SCALE: 1/4" = 1' - 0"

Identification **ST-446**

Descriptions: Curbside Check-In - Canopy Suspended (ALTERNATE)

Dimensions: 1'- 8" High x 5'- 0" Wide x 2 1/2" Deep

Location: Upper Level Curbside Check-In canopies.

Material: Exterior grade aluminum sign panel with front panel to receive applied Airline Graphics.

Colors: [C1] Sign Support Structure
- Seamless fabricated .040 thick aluminum panels painted to match canopy structure.
- No exposed fasteners.
- Panel face surface to receive full face graphic (by Airline)

Graphics: By respective Airline

Mounting: Mount to center canopy support. No visible fasteners. Sign contractor to coordinate with structural to develop mounting details to canopy.

Illuminations: None

Remarks: N/A

2.0 SIGN TYPES

#	REVISION	DATE
1	Updated	07/25/17
2	Updated	10/20/17

2.4 Sign Type Layouts

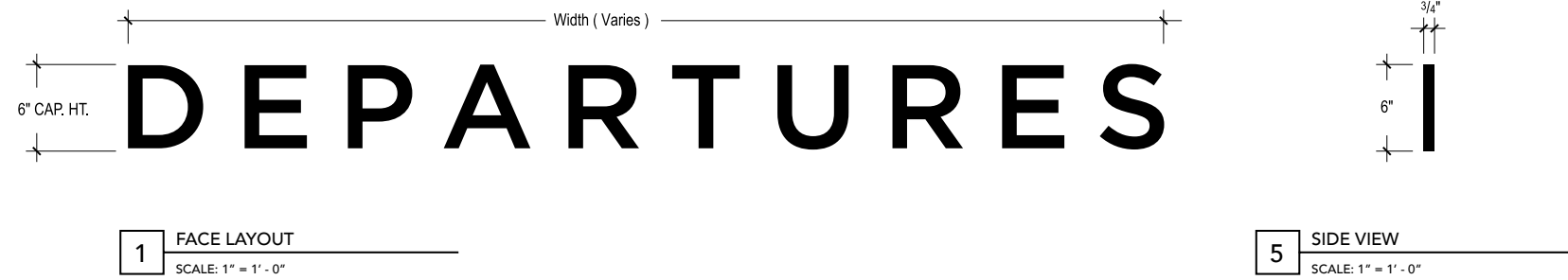

3 FRONT VIEW - FINISH
SCALE: NTS

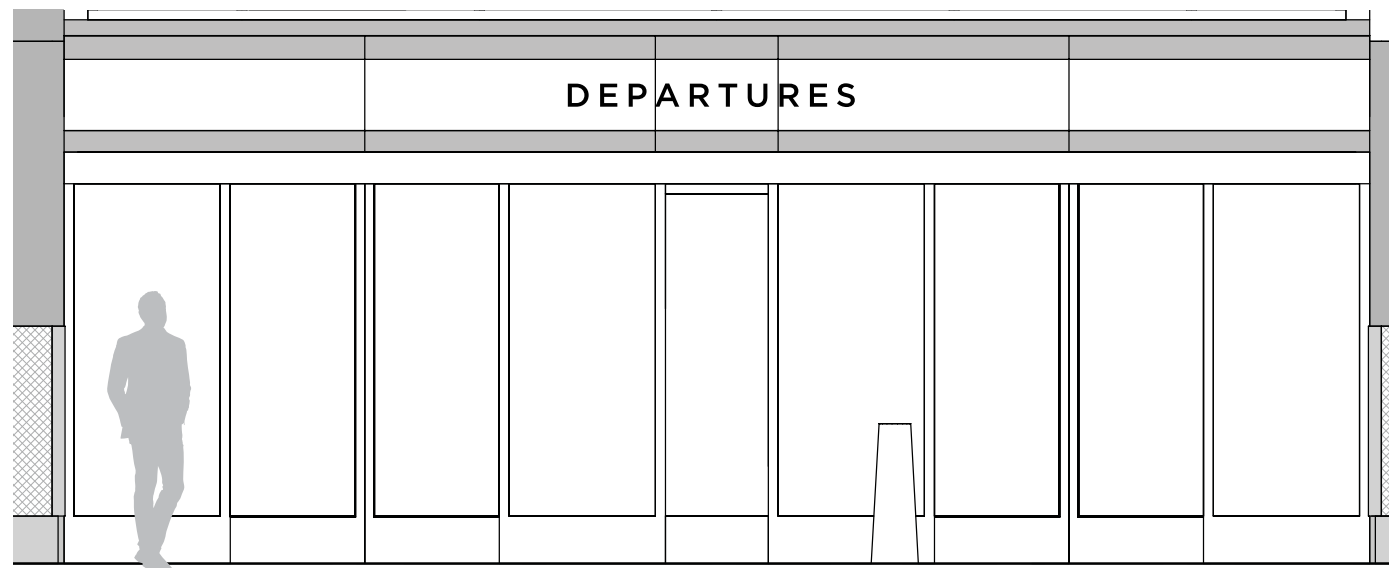

4 FACE LAYOUT
SCALE: 1/4" = 1' - 0"

Identification **ST-448**

Descriptions: Primary Identification (ALTERNATE)

Dimensions: 6" Tall x Width (Varies) x 3/4" Deep

Location: Lower Level Curbsides

Material: Exterior Grade Acrylic

Lettering: Gotham Medium

Symbology: N/A

Colors: C1 Fabricated Letters
 - .125" thick acrylic (Exterior Sign Grade Polycarbonate) dimensional letters.
 - Front face and returns painted to match assigned colors -
 - North Curbsides - Pantone 2935 (Blue)
 - South Curbsides - Pantone 1795 (Red)
 - International Curbsides - Pantone 123 (Yellow)

Graphics: N/A

Mounting: First Surface

Illuminations: None

Remarks: N/A

Notes:

1. Signs with messages to South Curbsides will utilize "red" accent bar (Pantone 1795) only.
2. Signs with directional messages to North Curbsides will utilize "blue" accent bar (Pantone 2935) only.
3. Signs with messages for International Curbsides will utilize "yellow" accent bar (Pantone 123) only.
4. Colors are not interchangeable, and cannot be substituted.

2.0 SIGN TYPES

#	REVISION	DATE
1	Updated	07/25/17
2	Updated	10/20/17

2.2 Sign Type Layouts

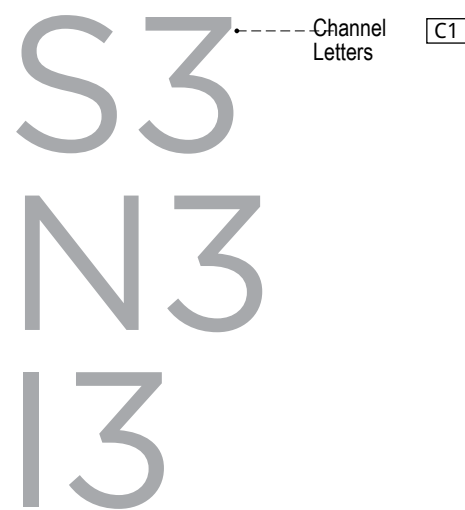
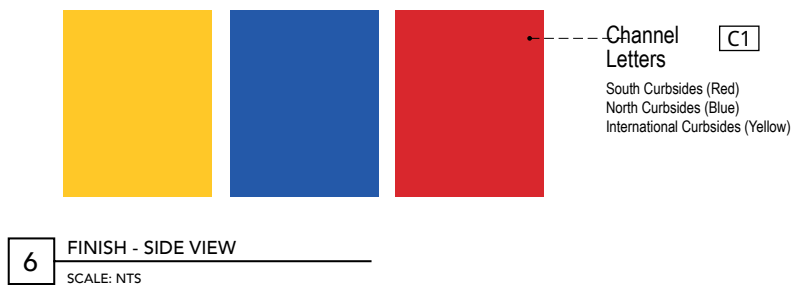
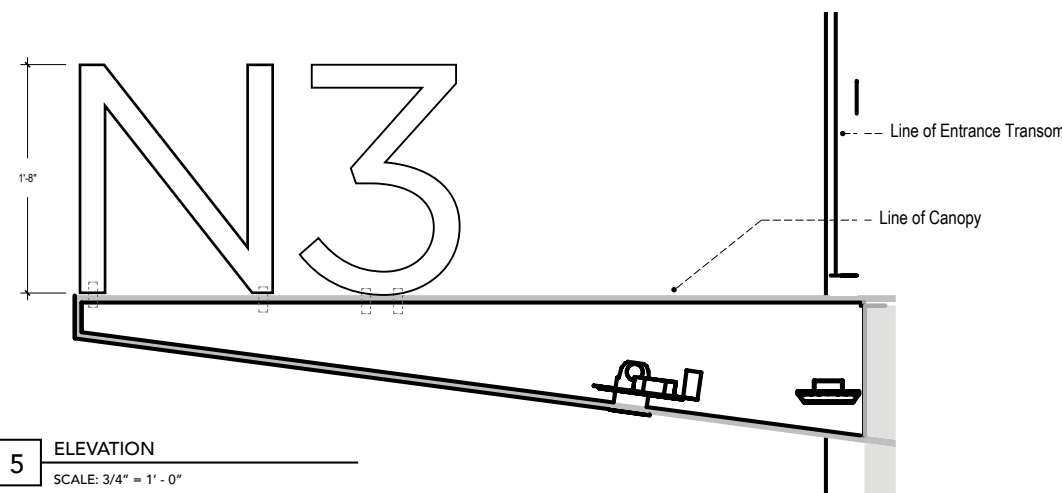
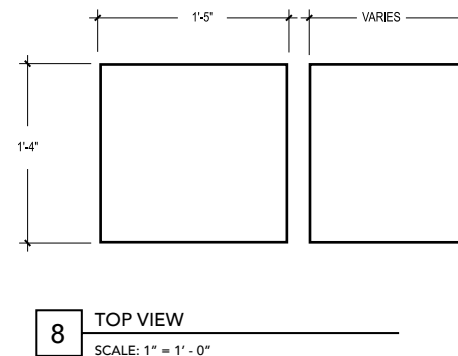
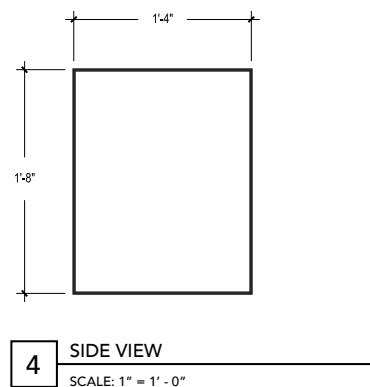
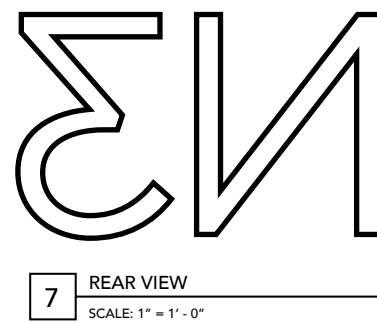
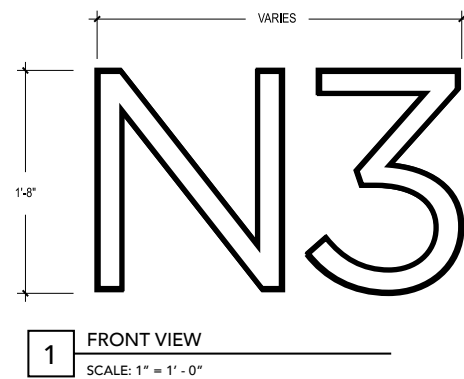

2 FINISH - FRONT VIEW
SCALE: NTS

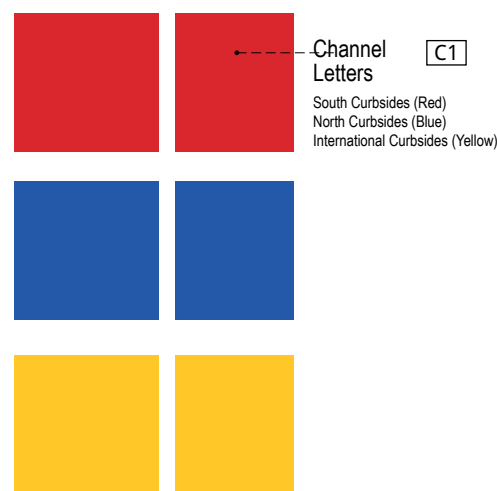

3 FINISH - TOP VIEW
SCALE: NTS



Identification **ST-450**

Descriptions: Door Identification Numbers

Dimensions: 1'- 8" High x Width (varies) x 1'- 4" Deep

Location: Upper Level Curbsides Entrance

Material: Exterior grade fabricated aluminum channel letters.

Lettering: Gotham Book

Symbology: N/A

Colors: [C1] Channel Letters
- Numbers and Letters to have thin strokes and deep returns.
- Front face painted to match canopy (silver)
- Returns and closed-off back of signs painted to match assigned accent colors for:
- North Curbsides - Pantone 2935 (Blue)
- South Curbsides - Pantone 1795 (Red)
- International Curbsides - Pantone 123 (Yellow)

Graphics: N/A

Mounting: Mount to top of canopy. No visible fasteners. Sign contractor to coordinate with structural to develop mounting details to canopy.

Illuminations: None

Remarks: N/A

Notes:

1. Signs with messages to South Curbsides will utilize "red" accent color (Pantone 1795) only.
2. Signs with directional messages to North Curbsides will utilize "blue" accent color (Pantone 2935) only.
3. Signs with messages for International Curbsides will utilize "yellow" accent color (Pantone 123) only.
4. Colors are not interchangeable, and cannot be substituted.

2.0 SIGN TYPES

#	REVISION	DATE
1	Updated	07/25/17
2	Updated	10/20/17

2.4 Sign Type Layouts

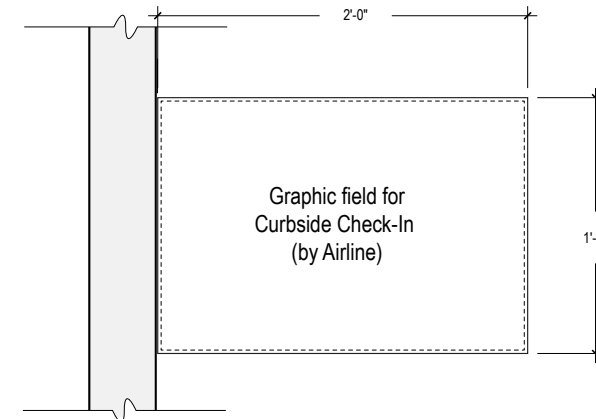
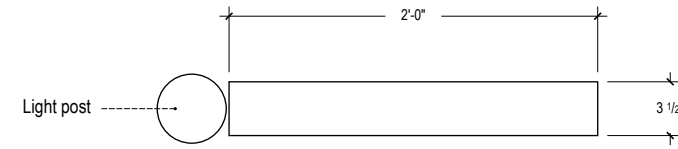
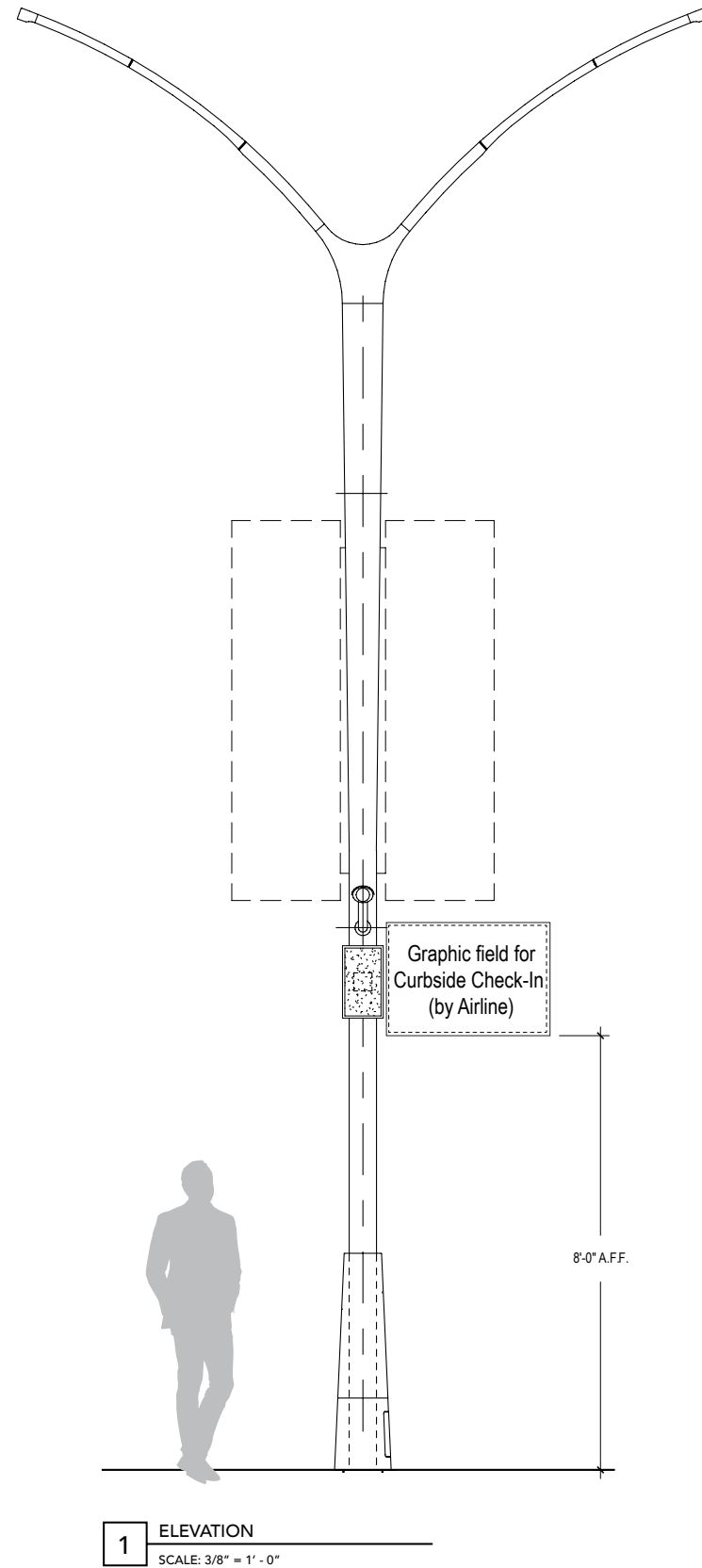

NOTE:
Fabricator to coordinate attachment with light post fabricator. Match attachment method used to attach large LED displays (Airline Identification)

Identification **ST-454**

Descriptions: Secondary Identification (ALTERNATE)

Dimensions: 1'- 4" High x 2'- 0" Wide x 3 1/2" Deep

Location: Upper Level Curbsides

Material: Exterior grade aluminum sign.

Lettering: N/A

Symbology: N/A

Colors: **C1** Sign Support Structure
- Seamless fabricated .040 thick aluminum, painted to match canopy structure.
- No exposed fasteners.
- Front panel face surface to receive full face graphics (by Airline).

Graphics: By respective Airline

Mounting:
- Flag mount to light pole at curbside check-in.
- Coordinate attachment with light post fabricator.

Illuminations: None

Remarks: N/A

2.0 SIGN TYPES

#	REVISION	DATE
1	Updated	07/25/17
2	Updated	10/20/17

2.4 Sign Type Layouts

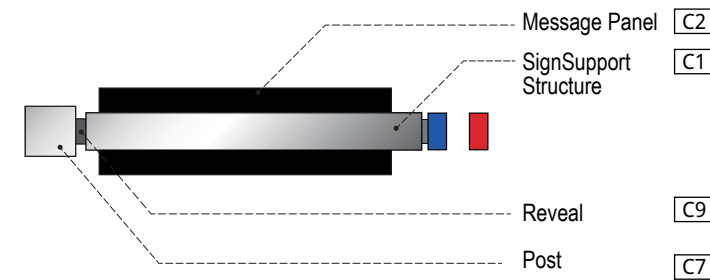

1 FINISH - TOP VIEW
SCALE: NTS

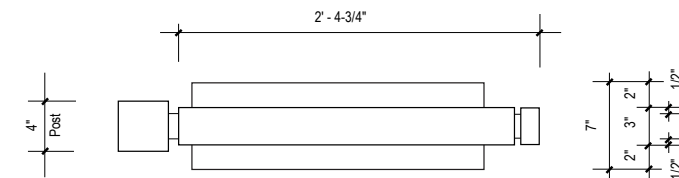

5 TOP VIEW
SCALE: 1" = 1' - 0"

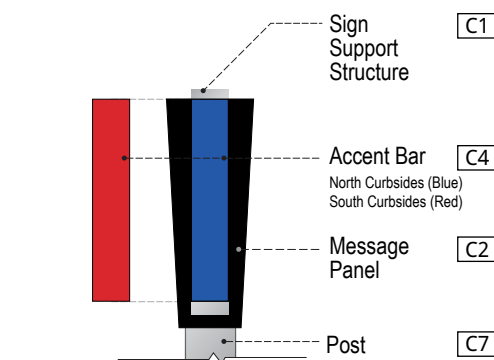

2 FINISH - END VIEW
SCALE: NTS

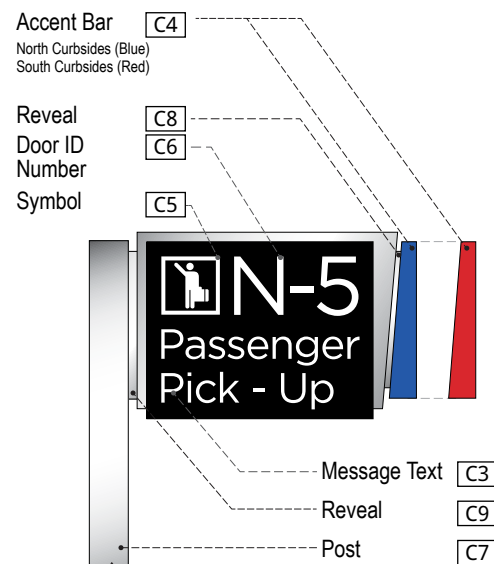

3 FINISH - FRONT VIEW
SCALE: NTS

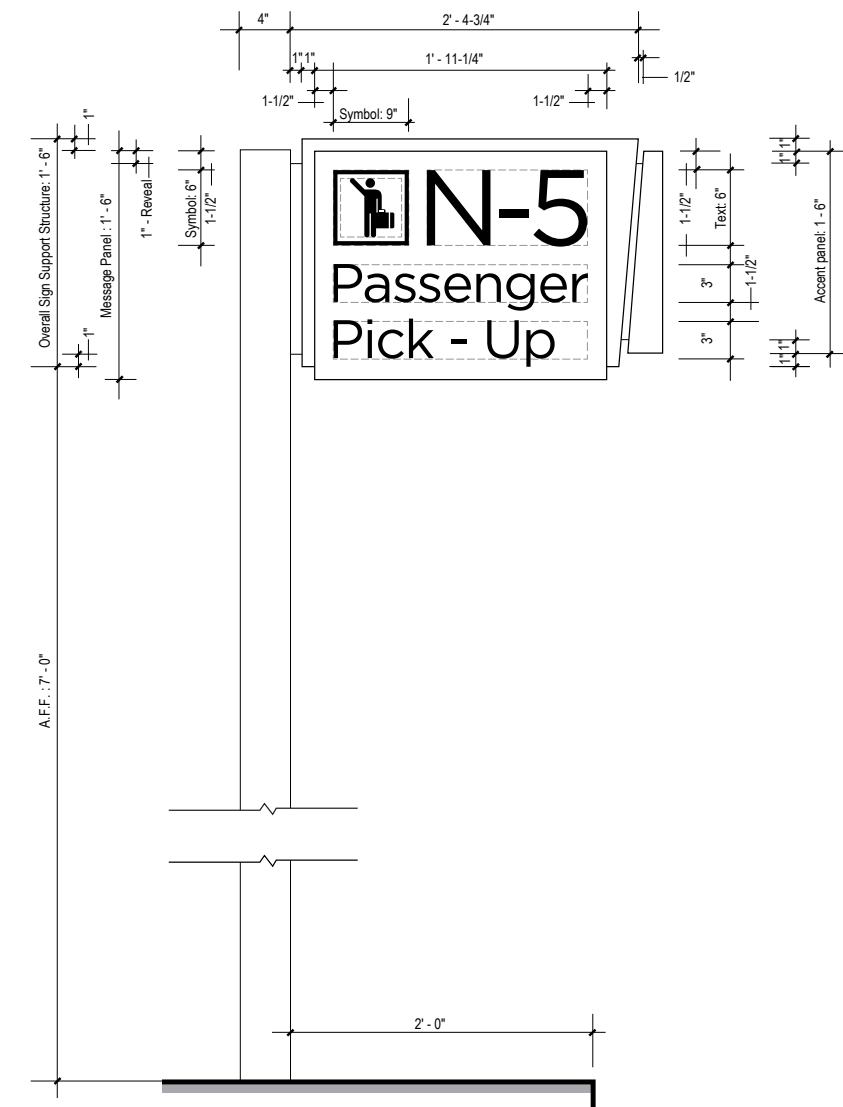

4 ELEVATION
SCALE: 1" = 1' - 0"

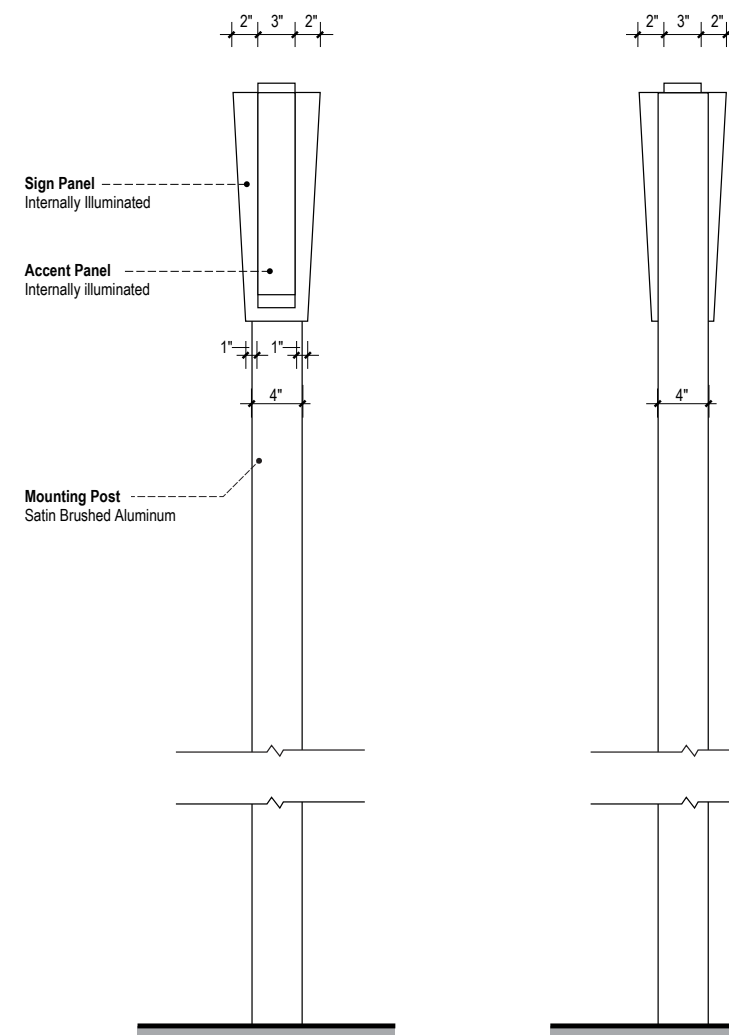

6 END VIEW - 1
SCALE: 1" = 1' - 0"

7 END VIEW - 2
SCALE: 1" = 1' - 0"

Identification **ST-460**

- Descriptions:** Secondary Identification
- Dimensions:** 8'- 6" High x 2'- 4-3/4" Wide x 7" Deep
- Location:** Upper and Lower Level Curbsides
- Material:** Exterior grade aluminum sign panel.
- Lettering:** Gotham Book
- Symbology:** N/A
- Colors:**
- C1** Sign Support Structure
 - Seamless fabricated .040 thick satin brushed aluminum.
 - No exposed fasteners
 - C2** Message Panel
 - .125" thick seamless fabricated white acrylic overplayed with opaque matte black vinyl with reverse cut copy.
 - Apply opaque black vinyl to sides and bottom returns.
 - Top return uncovered to create a glow on sign cabinet
 - Internally illuminated
 - C3** Messages - English
 - Internally illuminated (White)
 - C4** Accent Bars
 - .125" thick seamless fabricated clear acrylic (Translucent Exterior Sign Grade Polycarbonate) match assigned accent colors for:
 - North Curbsides - Pantone 2935 (Blue)
 - South Curbsides - Pantone 1795 (Red)
 - C5** Symbol
 - Internally illuminated (White)
 - C6** Mounting Support
 - Satin brushed square aluminum post.
 - C7** Reveal
 - Satin brushed aluminum
- Graphics:** N/A
- Mounting:** Flag Mounted
- Illuminations:** Internal
- Remarks:** N/A

- Notes:**
1. Signs with informational messages for South Curbsides will utilize "red" accent bar (Pantone 1795) only.
 2. Signs with informational messages for North Curbsides will utilize "blue" accent bar (Pantone 2935) only.
 3. Colors are not interchangeable, and cannot be substituted.

2.0 SIGN TYPES

#	REVISION	DATE
1	Updated	07/25/17
2	Updated	10/20/17

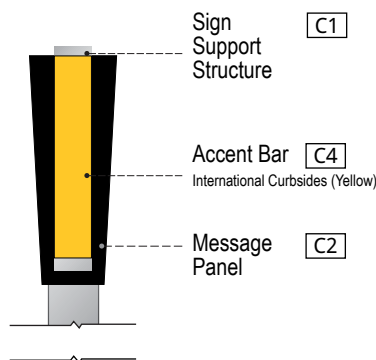

2 FINISH - END VIEW
SCALE: NTS

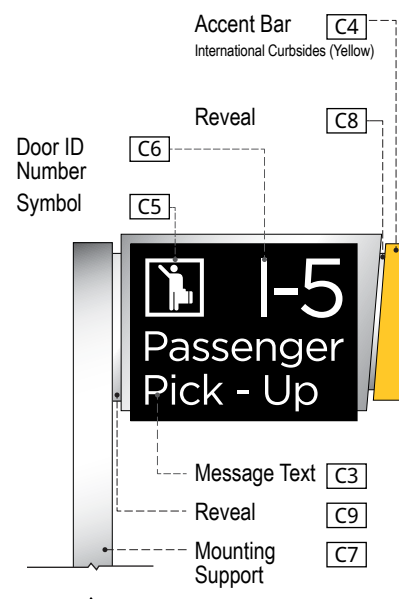

3 FINISH - FRONT VIEW
SCALE: NTS

2.4 Sign Type Layouts

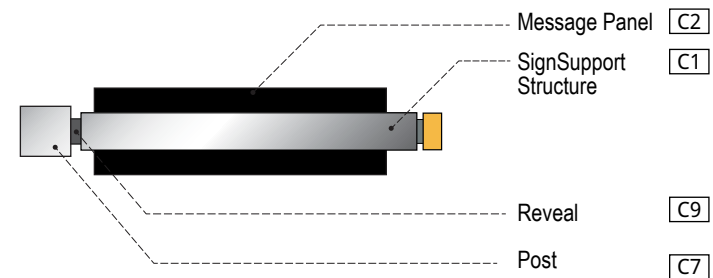

1 FINISH - TOP VIEW
SCALE: NTS

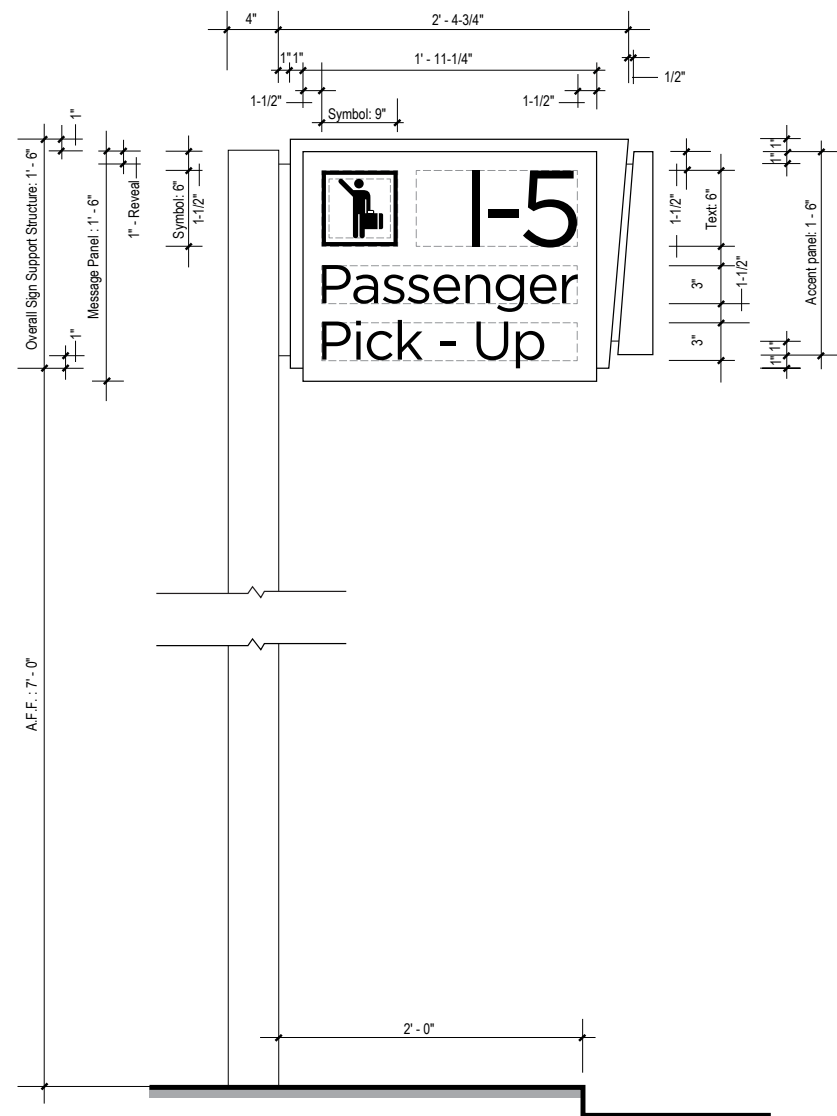

4 ELEVATION
SCALE: 1" = 1' - 0"

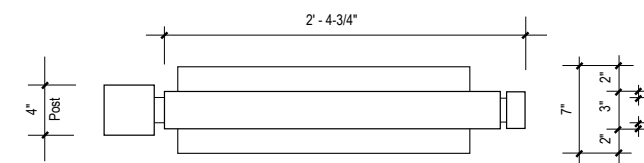

5 TOP VIEW
SCALE: 1" = 1' - 0"

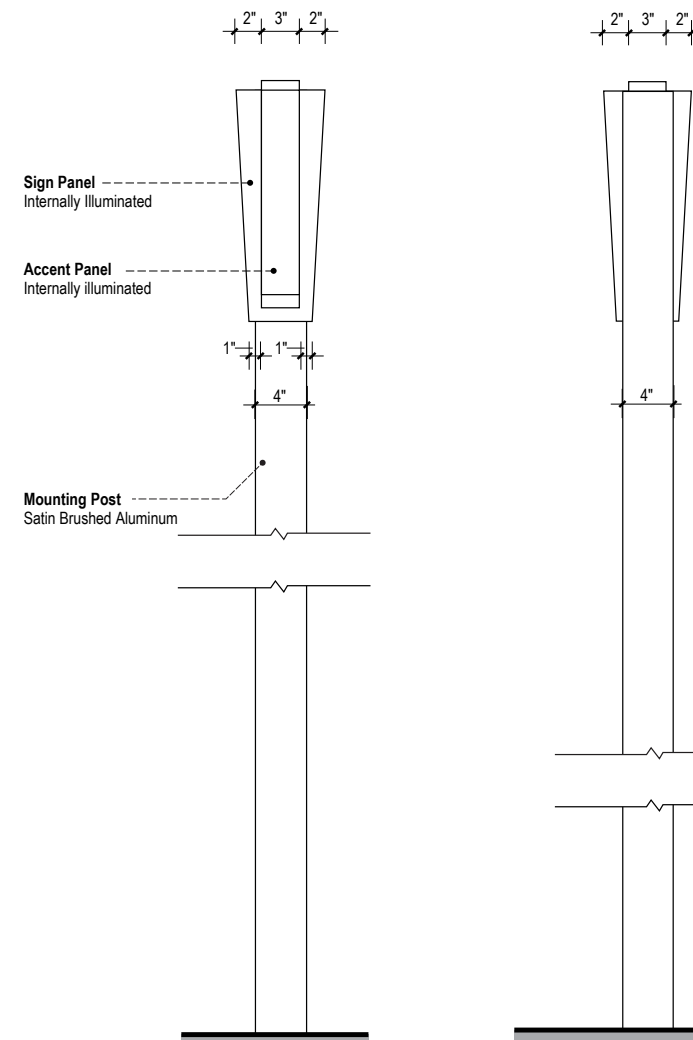

6 END VIEW - 1
SCALE: 1" = 1' - 0"

7 END VIEW - 2
SCALE: 1" = 1' - 0"

Identification ST-460

- Descriptions:** Secondary Identification
- Dimensions:** 8'- 6" High x 2'- 4-3/4" Wide x 7" Deep
- Location:** Upper and Lower Level Curbsides
- Material:** Exterior grade aluminum sign panel.
- Lettering:** Gotham Book
- Symbology:** N/A
- Colors:**
- [C1] Sign Support Structure
 - Seamless fabricated .040 thick satin brushed aluminum.
 - No exposed fasteners
 - [C2] Message Panel
 - .125" thick seamless fabricated white acrylic overplayed with opaque matte black vinyl with reverse cut copy.
 - Apply opaque black vinyl to sides and bottom returns.
 - Top return uncovered to create a glow on sign cabinet
 - Internally illuminated
 - [C3] Messages - English
 - Internally illuminated (White)
 - [C4] Accent Bars
 - .125" thick seamless fabricated clear acrylic (Translucent Exterior Sign Grade Polycarbonate) match assigned accent colors for:
 - North Curbsides - Pantone 2935 (Blue)
 - South Curbsides - Pantone 1795 (Red)
 - [C5] Symbol
 - Internally illuminated (White)
 - [C6] Mounting Support
 - Satin brushed square aluminum post.
 - [C7] Reveal
 - Satin brushed aluminum
- Graphics:** N/A
- Mounting:** Flag Mounted
- Illuminations:** Internal
- Remarks:** N/A

Notes:

1. Signs with informational messages for International Terminal will utilize "yellow" accent bar (Pantone 123) only.
2. Colors are not interchangeable, and cannot be substituted.

2.0 SIGN TYPES

#	REVISION	DATE
1	Updated	07/25/17
2	Updated	10/20/17

2.4 Sign Type Layouts

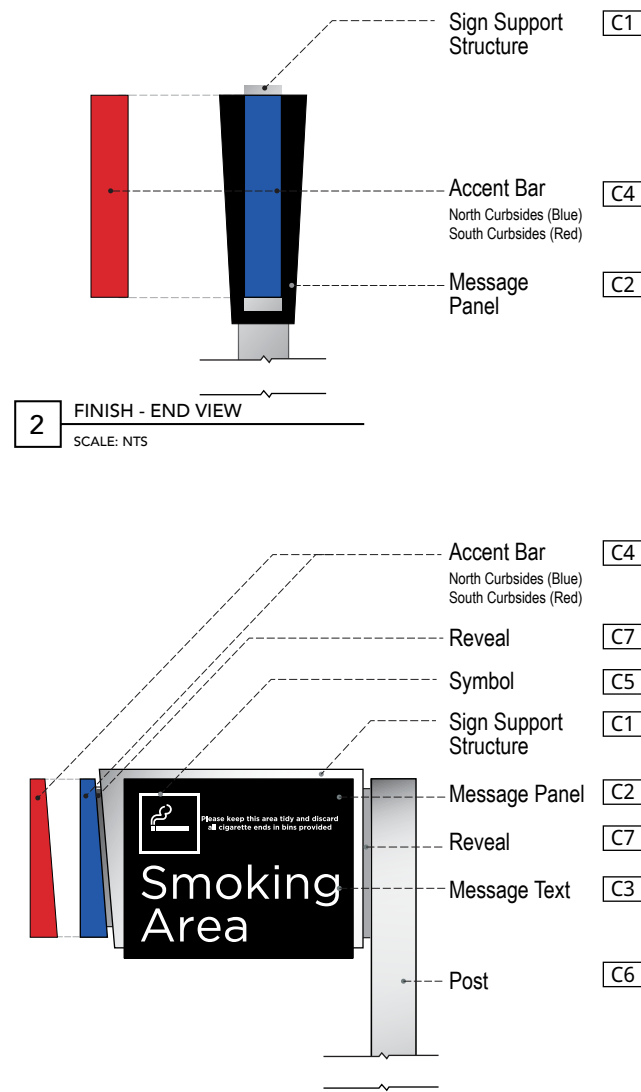

2 FINISH - END VIEW
SCALE: NTS

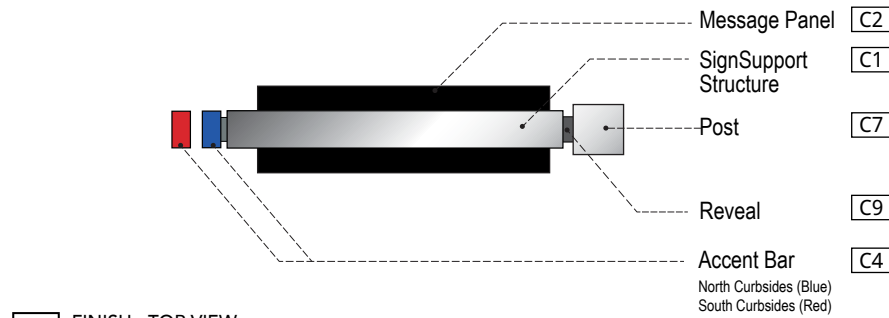

1 FINISH - TOP VIEW
SCALE: NTS

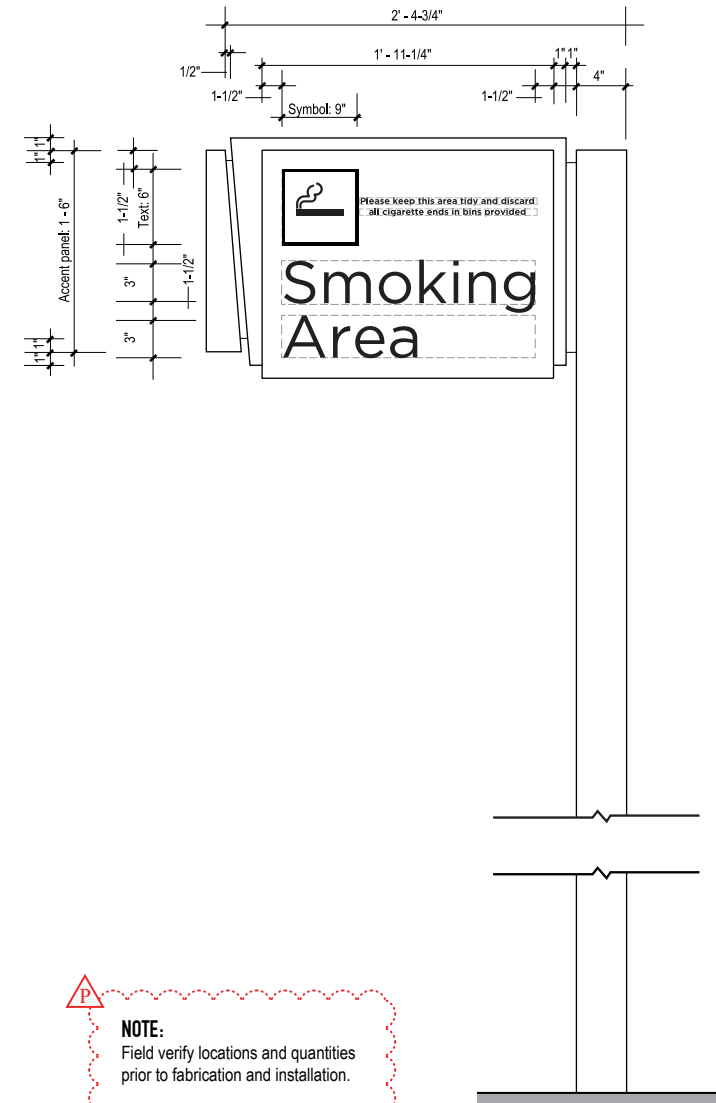

4 ELEVATION
SCALE: 1" = 1' - 0"

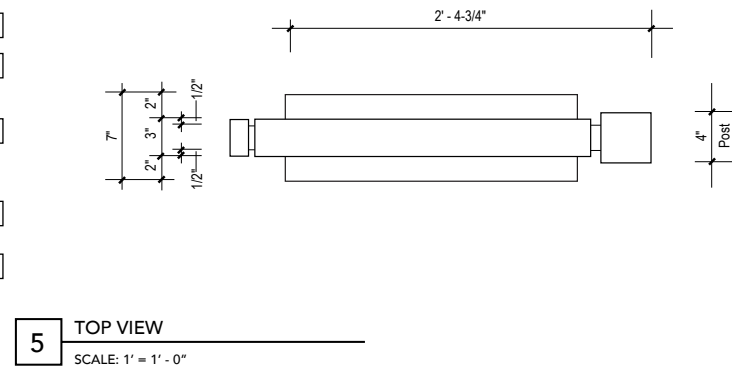

5 TOP VIEW
SCALE: 1" = 1' - 0"

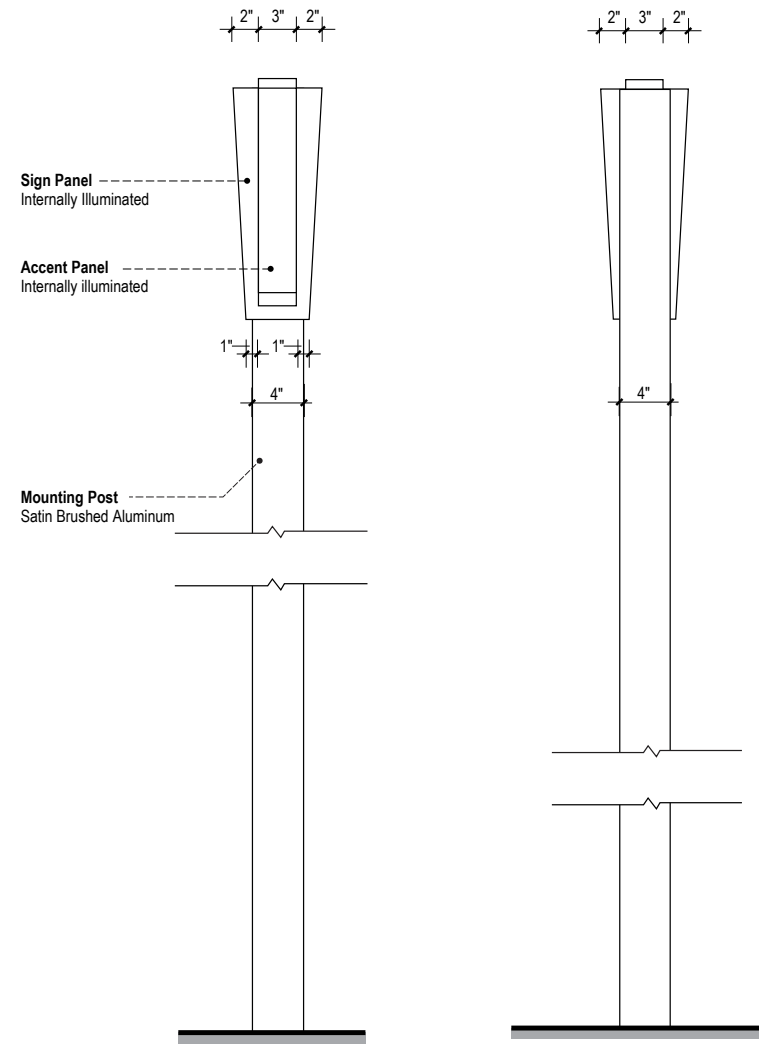

6 END VIEW - 1
SCALE: 1" = 1' - 0"

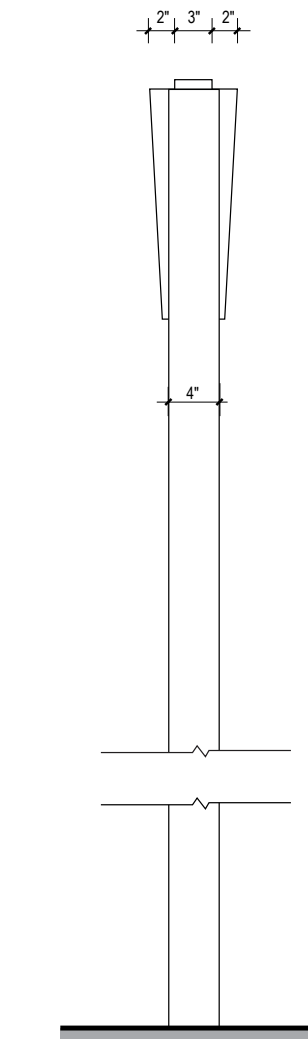

7 END VIEW - 2
SCALE: 1" = 1' - 0"

Identification ST-462

- Descriptions:** Secondary Identification
- Dimensions:** 8'- 6" High x 2'- 4-3/4" Wide x 7" Deep
- Location:** Upper and Lower Level Curbsides
- Material:** Exterior grade aluminum sign panel.
- Lettering:** Gotham Book
- Symbology:** N/A
- Colors:**
- C1** Sign Support Structure
 - Seamless fabricated .040 thick satin brushed aluminum.
 - No exposed fasteners
 - C2** Message Panel
 - .125" thick seamless fabricated white acrylic overplayed with opaque matte black vinyl with reverse cut copy.
 - Apply opaque black vinyl to sides and bottom returns.
 - Top return uncovered to create a glow on sign cabinet
 - Internally illuminated
 - C3** Messages - English
 - Internally illuminated (White)
 - C4** Accent Bars
 - .125" thick seamless fabricated clear acrylic (Translucent Exterior Sign Grade Polycarbonate) match assigned accent colors for:
 - North Curbsides - Pantone 2935 (Blue)
 - South Curbsides - Pantone 1795 (Red)
 - C5** Symbol
 - Internally illuminated (White)
 - C6** Mounting Support
 - Satin brushed square aluminum post.
 - C7** Reveal
 - Satin brushed aluminum
- Graphics:** N/A
- Mounting:** Flag Mounted
- Illuminations:** Internal
- Remarks:** N/A

- Notes:**
1. Signs with messages to South Curbsides will utilize "red" accent bar (Pantone 1795) only.
 2. Signs with directional messages to North Curbsides will utilize "blue" accent bar (Pantone 2935) only.
 3. Colors are not interchangeable, and cannot be substituted.

2.0 SIGN TYPES

#	REVISION	DATE
1	Updated	07/25/17
2	Updated	10/20/17

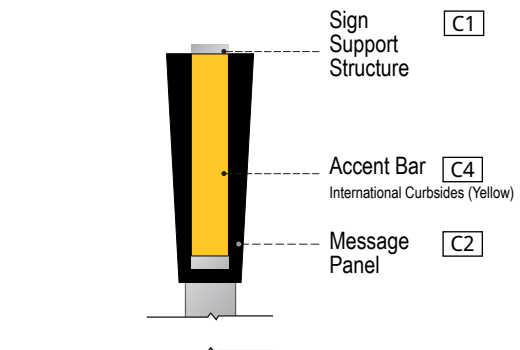

2 SIGN FINISHES
SCALE: NTS

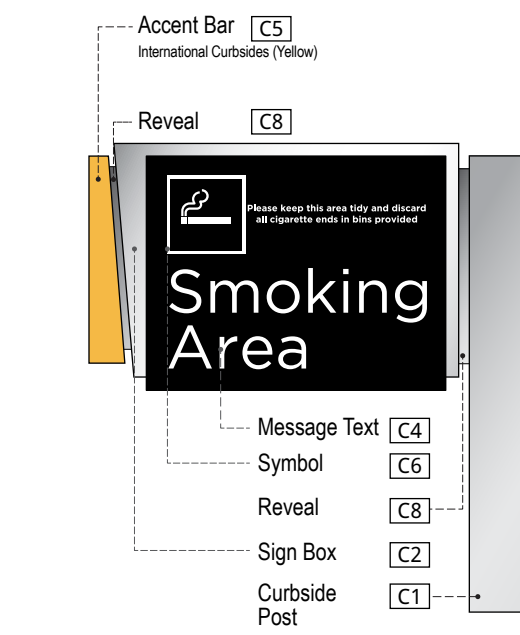

3 SIGN FINISHES
SCALE: NTS

2.4 Sign Type Layouts

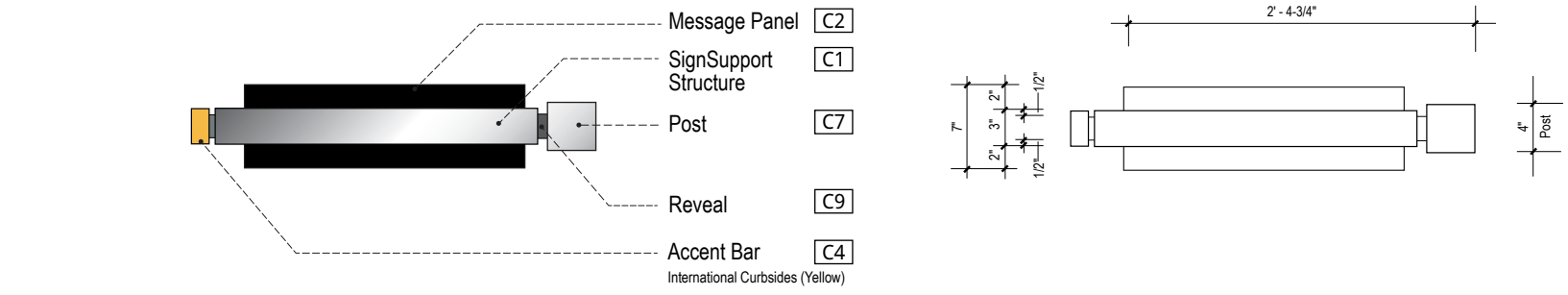

1 FINISH - TOP VIEW
SCALE: NTS

5 TOP VIEW
SCALE: 1" = 1' - 0"

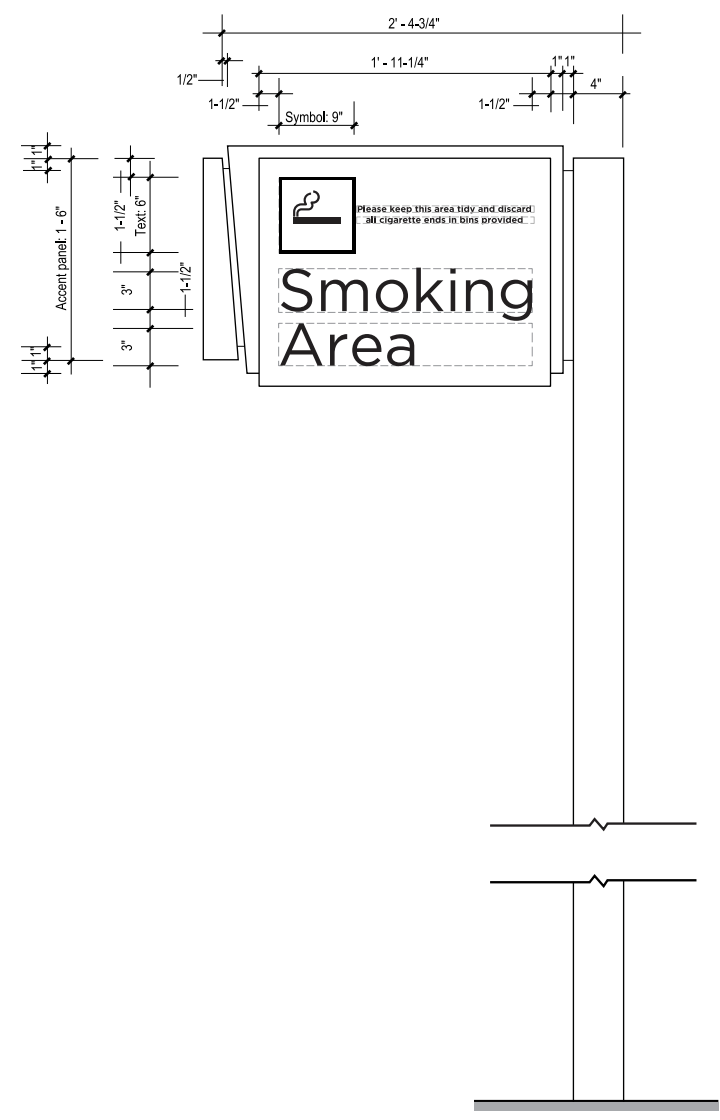

4 ELEVATION
SCALE: 1" = 1' - 0"

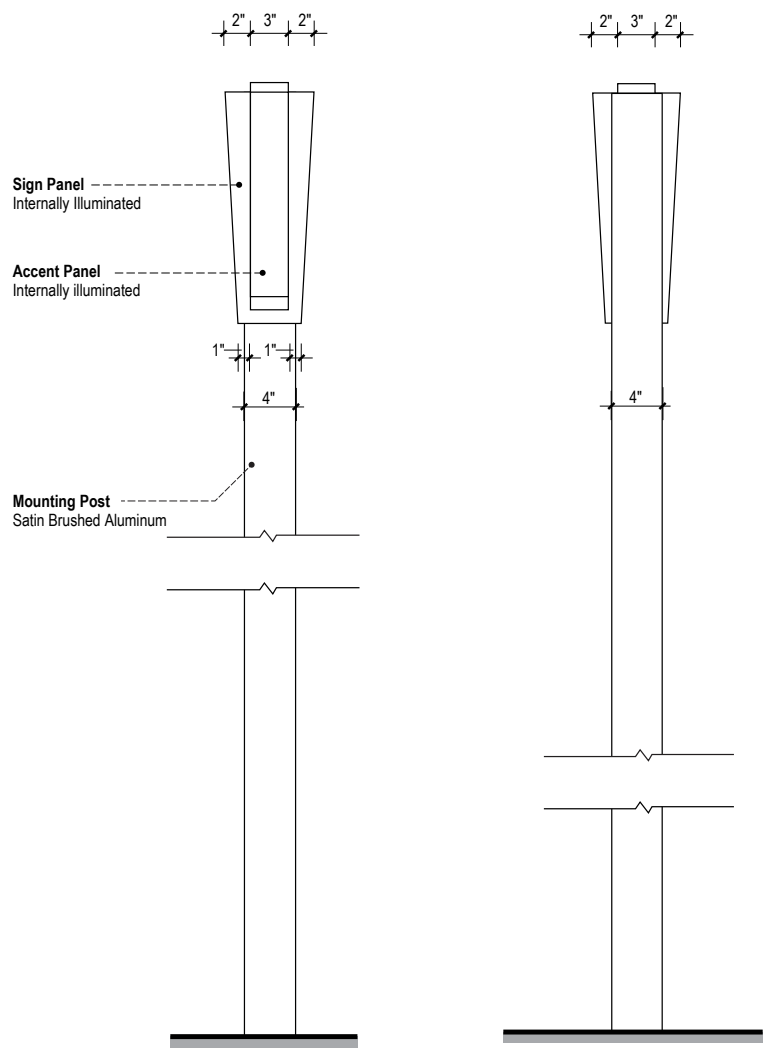

6 END VIEW - 1
SCALE: 1" = 1' - 0"

7 END VIEW - 2
SCALE: 1" = 1' - 0"

Identification ST-462

- Descriptions:** Secondary Identification
- Dimensions:** 8'- 6" High x 2'- 4-3/4" Wide x 7" Deep
- Location:** Upper and Lower Level Curbsides
- Material:** Exterior grade aluminum sign panel.
- Lettering:** Gotham Book
- Symbology:** N/A
- Colors:**
- C1** Sign Support Structure
 - Seamless fabricated .040 thick satin brushed aluminum.
 - No exposed fasteners
 - C2** Message Panel
 - .125" thick seamless fabricated white acrylic overplayed with opaque matte black vinyl with reverse cut copy.
 - Apply opaque black vinyl to sides and bottom returns.
 - Top return uncovered to create a glow on sign cabinet
 - Internally illuminated
 - C3** Messages - English
 - Internally illuminated (White)
 - C4** Accent Bars
 - .125" thick seamless fabricated clear acrylic (Translucent Exterior Sign Grade Polycarbonate) match assigned accent colors for:
 - North Curbsides - Pantone 2935 (Blue)
 - South Curbsides - Pantone 1795 (Red)
 - C5** Symbol
 - Internally illuminated (White)
 - C6** Mounting Support
 - Satin brushed square aluminum post.
 - C7** Reveal
 - Satin brushed aluminum
- Graphics:** N/A
- Mounting:** Flag Mounted
- Illuminations:** Internal
- Remarks:** N/A

Notes:

1. Signs with messages to International Curbsides will utilize "yellow" accent bar (Pantone 123) only.
2. Colors are not interchangeable, and cannot be substituted.

2.0 SIGN TYPES

#	REVISION	DATE
1	Updated	07/25/17
2	Updated	10/20/17

2.4 Sign Type Layouts

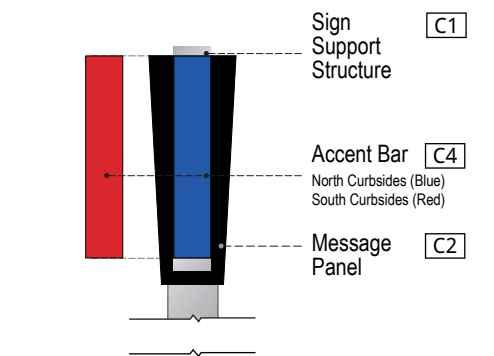

2 SIGN FINISHES
SCALE: NTS

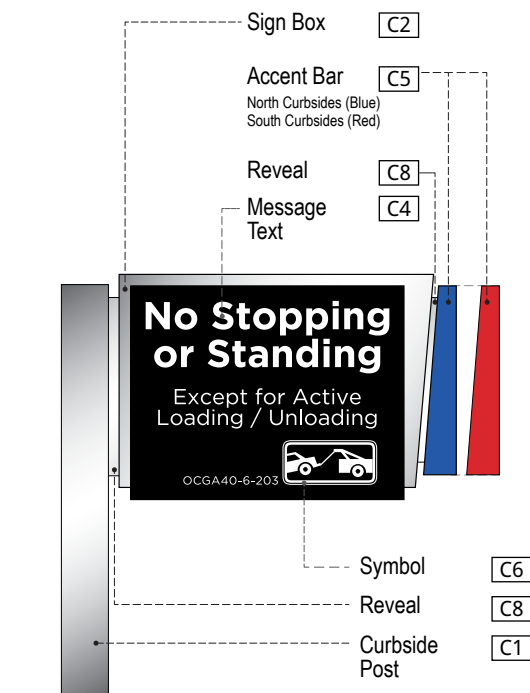

3 SIGN FINISHES
SCALE: NTS

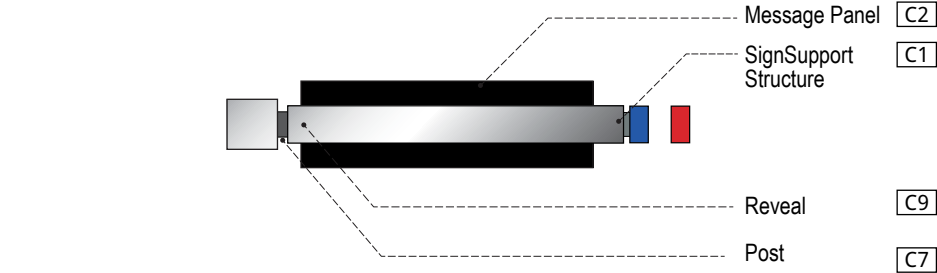

1 FINISH - TOP VIEW
SCALE: NTS

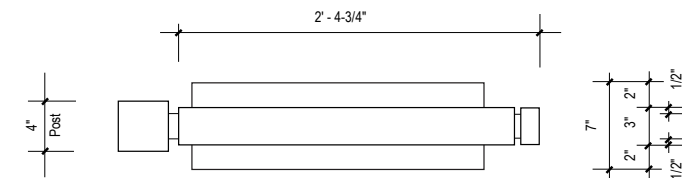

6 TOP VIEW
SCALE: 1" = 1' - 0"

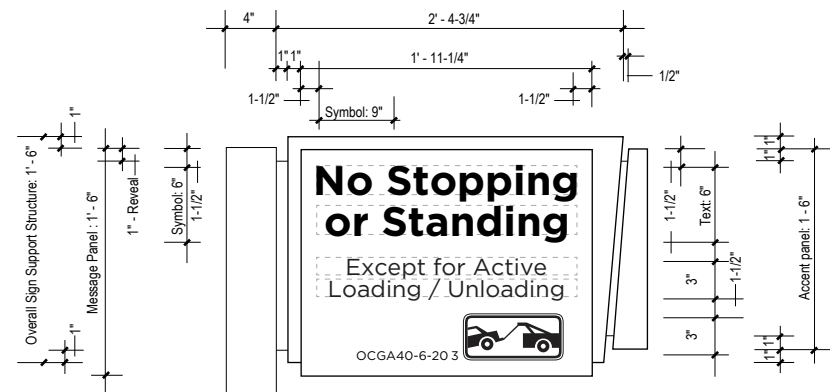

4 FRONT VIEW PASSENGER PICK-UP
SCALE: 1" = 1' - 0"



5 ALTERNATE LAYOUT
SCALE: 1 1/2" = 1' - 0"

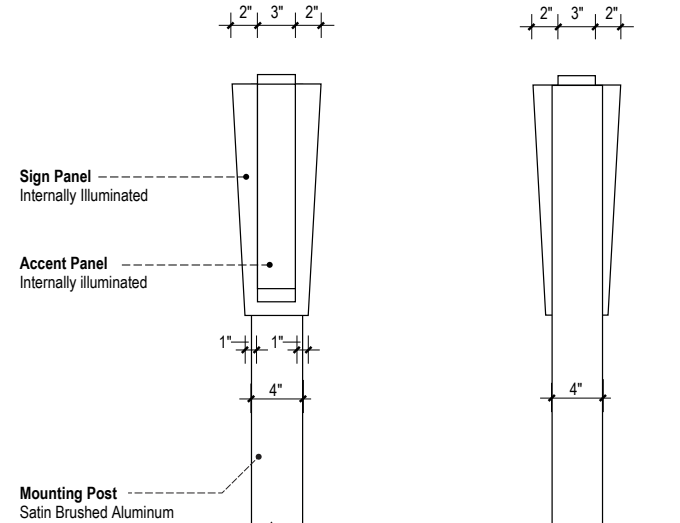

7 END VIEW - 1
SCALE: 1" = 1' - 0"

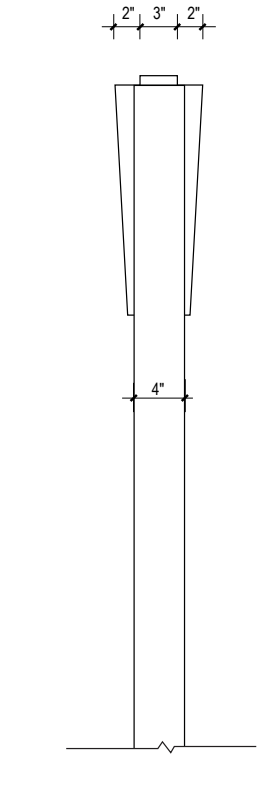

8 END VIEW - 2
SCALE: 1" = 1' - 0"

Regulatory **ST-464**

- Descriptions:** Secondary Identification
- Dimensions:** 8'- 6" High x 2'- 4-3/4" Wide x 7" Deep
- Location:** Upper and Lower Level Curbsides
- Material:** Exterior grade aluminum sign panel.
- Lettering:** Gotham Book
- Symbology:** N/A
- Colors:**
- [C1] Sign Support Structure
 - Seamless fabricated .040 thick satin brushed aluminum.
 - No exposed fasteners
 - [C2] Message Panel
 - .125" thick seamless fabricated white acrylic overplayed with opaque matte black vinyl with reverse cut copy.
 - Apply opaque black vinyl to sides and bottom returns.
 - Top return uncovered to create a glow on sign cabinet
 - Internally illuminated
 - [C3] Messages - English
 - Internally illuminated (White)
 - [C4] Accent Bars
 - .125" thick seamless fabricated clear acrylic (Translucent Exterior Sign Grade Polycarbonate) match assigned accent colors for:
 - North Curbsides - Pantone 2935 (Blue)
 - South Curbsides - Pantone 1795 (Red)
 - [C5] Symbol
 - Internally illuminated (White)
 - [C6] Mounting Support
 - Satin brushed square aluminum post.
 - [C7] Reveal
 - Satin brushed aluminum
- Graphics:** N/A
- Mounting:** Flag Mounted
- Illuminations:** Internal
- Remarks:** N/A

Notes:

1. Signs with messages to South Curbsides will utilize "red" accent bar (Pantone 1795) only.
2. Signs with directional messages to North Curbsides will utilize "blue" accent bar (Pantone 2935) only.
3. Colors are not interchangeable, and cannot be substituted.

2.0 SIGN TYPES

#	REVISION	DATE
1	Updated	07/25/17
2	Updated	10/20/17

2.4 Sign Type Layouts

- Descriptions:** Secondary Identification
- Dimensions:** 8'- 6" High x 2'- 4-3/4" Wide x 7" Deep
- Location:** Upper and Lower Level Curbsides
- Material:** Exterior grade aluminum sign panel.
- Lettering:** Gotham Book
- Symbology:** N/A
- Colors:**
- [C1]** Sign Support Structure
 - Seamless fabricated .040 thick satin brushed aluminum.
 - No exposed fasteners
 - [C2]** Message Panel
 - .125" thick seamless fabricated white acrylic overplayed with opaque matte black vinyl with reverse cut copy.
 - Apply opaque black vinyl to sides and bottom returns.
 - Top return uncovered to create a glow on sign cabinet
 - Internally illuminated
 - [C3]** Messages - English
 - Internally illuminated (White)
 - [C4]** Accent Bars
 - .125" thick seamless fabricated clear acrylic (Translucent Exterior Sign Grade Polycarbonate) match assigned accent colors for:
 - North Curbsides - Pantone 2935 (Blue)
 - South Curbsides - Pantone 1795 (Red)
 - [C5]** Symbol
 - Internally illuminated (White)
 - [C6]** Mounting Support
 - Satin brushed square aluminum post.
 - [C7]** Reveal
 - Satin brushed aluminum
- Graphics:** N/A
- Mounting:** Flag Mounted
- Illuminations:** Internal
- Remarks:** N/A

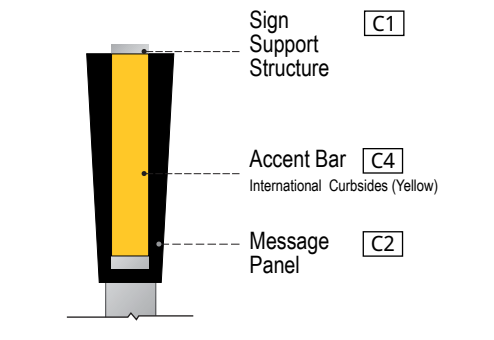

2 SIGN FINISHES
SCALE: NTS

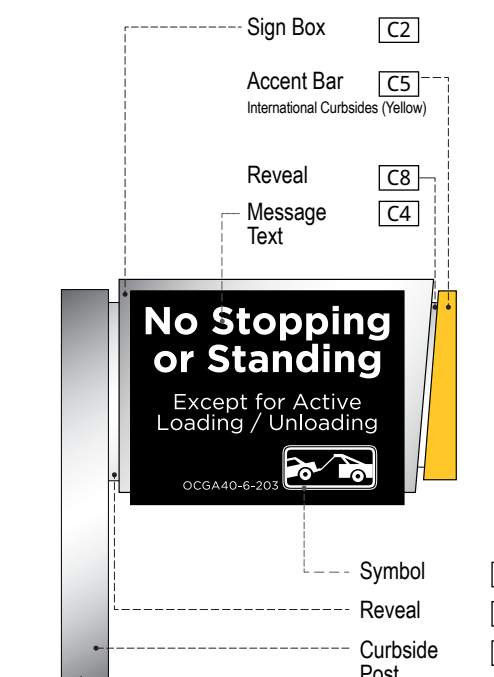

3 SIGN FINISHES
SCALE: NTS

1 FINISH - TOP VIEW
SCALE: NTS

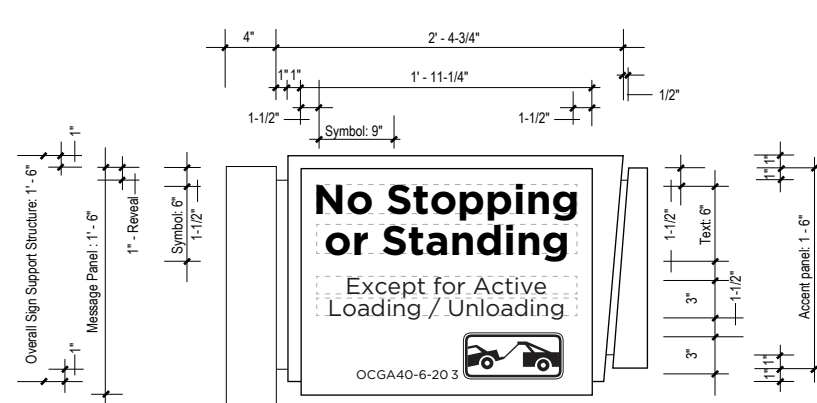

4 FRONT VIEW PASSENGER PICK-UP
SCALE: 1 = 1' - 0"

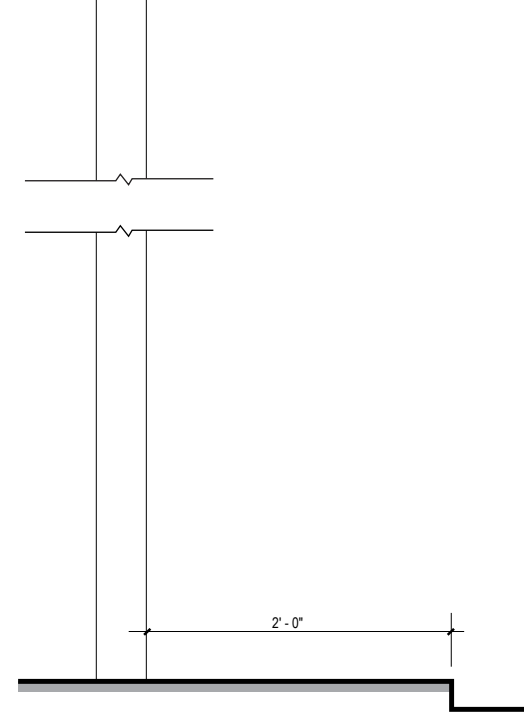

5 ALTERNATE LAYOUT
SCALE: 1 1/2" = 1' - 0"

6 TOP VIEW
SCALE: 1" = 1' - 0"

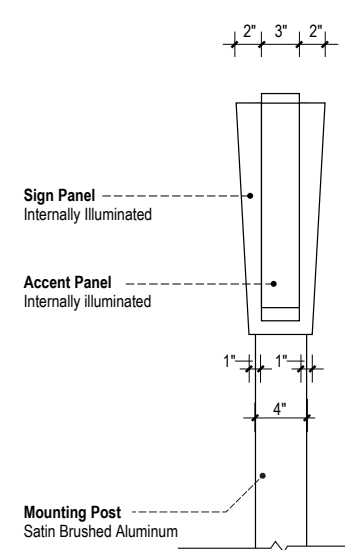
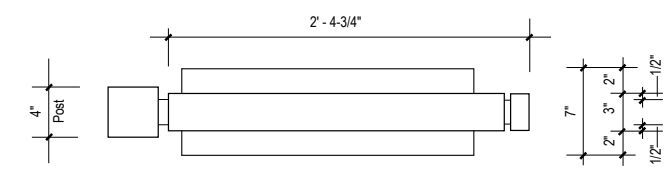

7 END VIEW - 1
SCALE: 1" = 1' - 0"

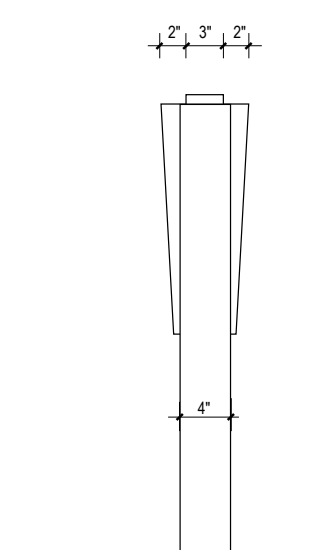

8 END VIEW - 2
SCALE: 1" = 1' - 0"

Notes:
1. Signs with messages to International Curbsides will utilize "yellow" accent bar (Pantone 123) only.
2. Colors are not interchangeable, and cannot be substituted.

2.0 SIGN TYPES

#	REVISION	DATE
1	Updated	07/25/17
2	Updated	10/20/17

2.4 Sign Type Layouts



1 FRONT VIEW - DOOR NUMBER
SCALE: 1" = 1' - 0"

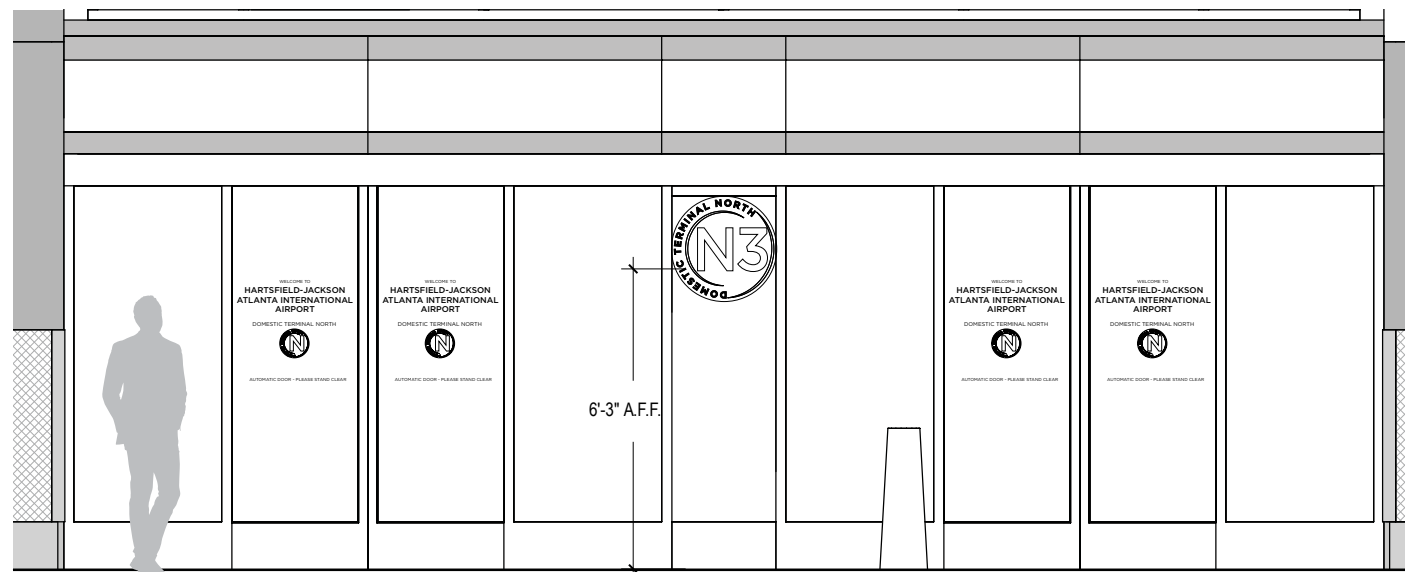

2 ELEVATION
SCALE: 1/4" = 1' - 0"

Identification ST-470

Descriptions: Door Identification (ALTERNATE)
Dimensions: 2'- 0" Dia.
Location: Upper and Lower Level Curbsides
Material: Exterior Grade Vinyl
Lettering: Gotham Medium
Symbology: N/A
Colors: C1 Door Identification
 - Machine cut opaque white acrylic
Graphics: N/A
Mounting: First surface on glass
Illuminations: None
Remarks: Submit material color for review / approval prior to fabrication.

2.0 SIGN TYPES

#	REVISION	DATE
1	Updated	07/25/17
2	Updated	10/20/17

2.4 Sign Type Layouts

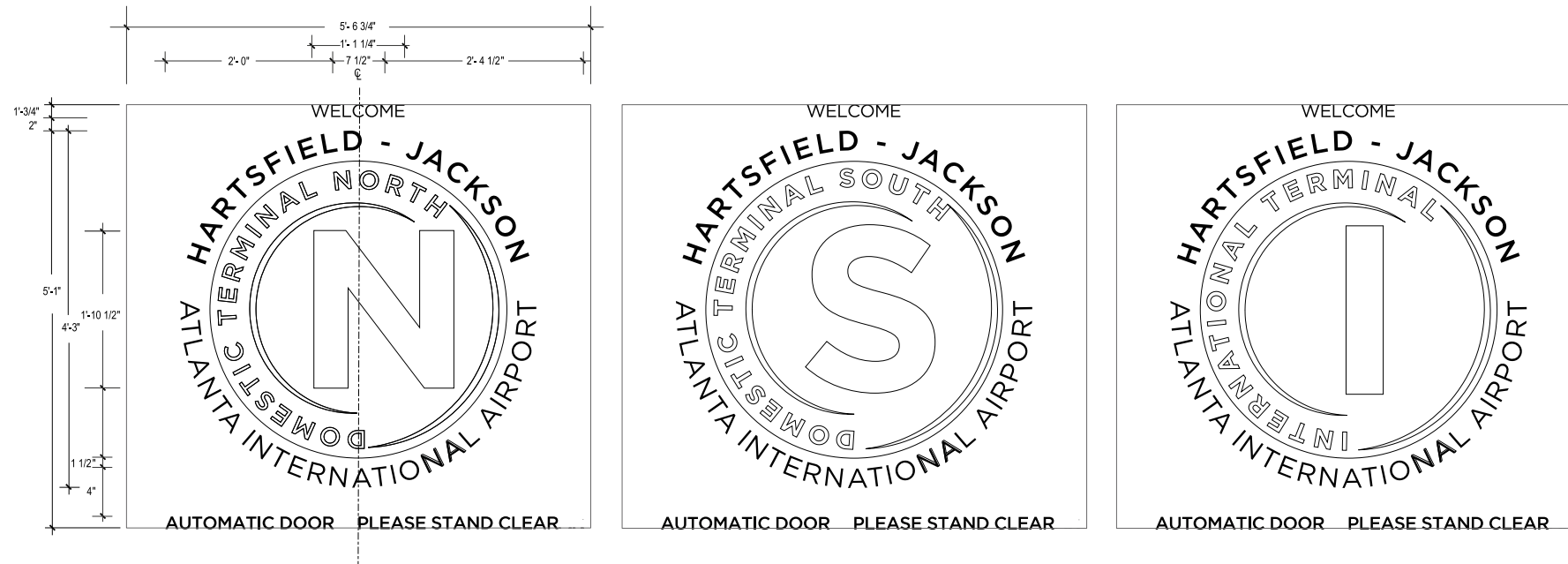

1 TERMINAL IDENTIFICATION
SCALE: 3" = 1' - 0"

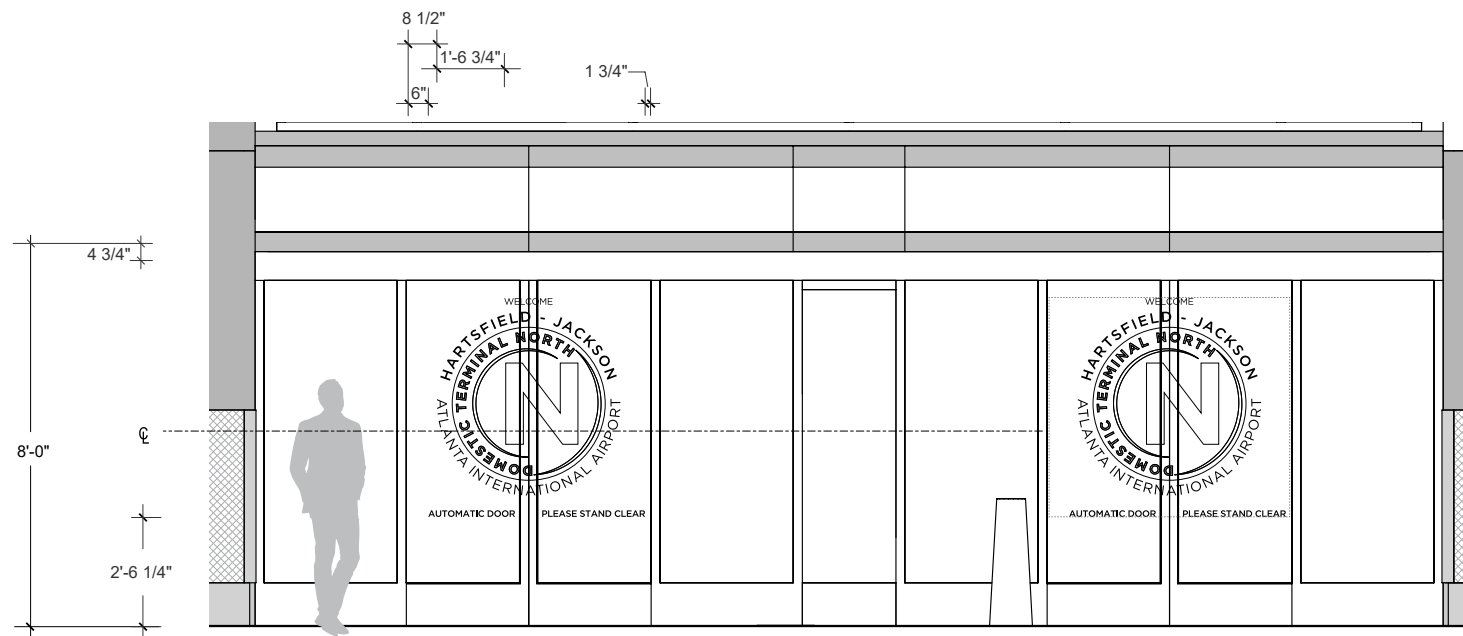

2 ELEVATION
SCALE: 1/4" = 1' - 0"

Identification ST-472

Descriptions: Terminal Identification
Dimensions: 2'- 0" Dia.
Location: Upper and Lower Level Curbsides
Material: Exterior Grade Vinyl
Lettering: Gotham Medium
Symbology: N/A
Colors: C1 Door Identification
 - Machine cut opaque white acrylic
Graphics: N/A
Mounting: First surface on glass
Illuminations: None
Remarks: Submit material color for review / approval prior to fabrication.

2.0 SIGN TYPES

2.4 Sign Type Layouts

Identification **ST-472**

#	REVISION	DATE
1	Updated	07/25/17
2	Updated	10/20/17

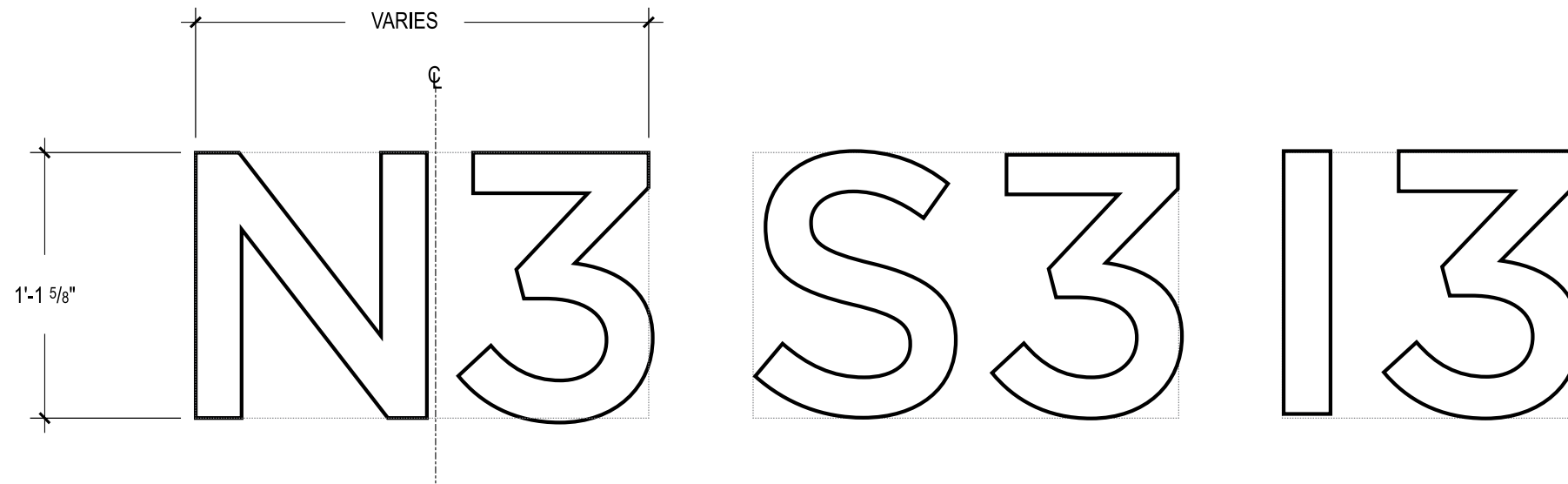

1 DOOR IDENTIFICATION
SCALE: 1" = 1' - 0"

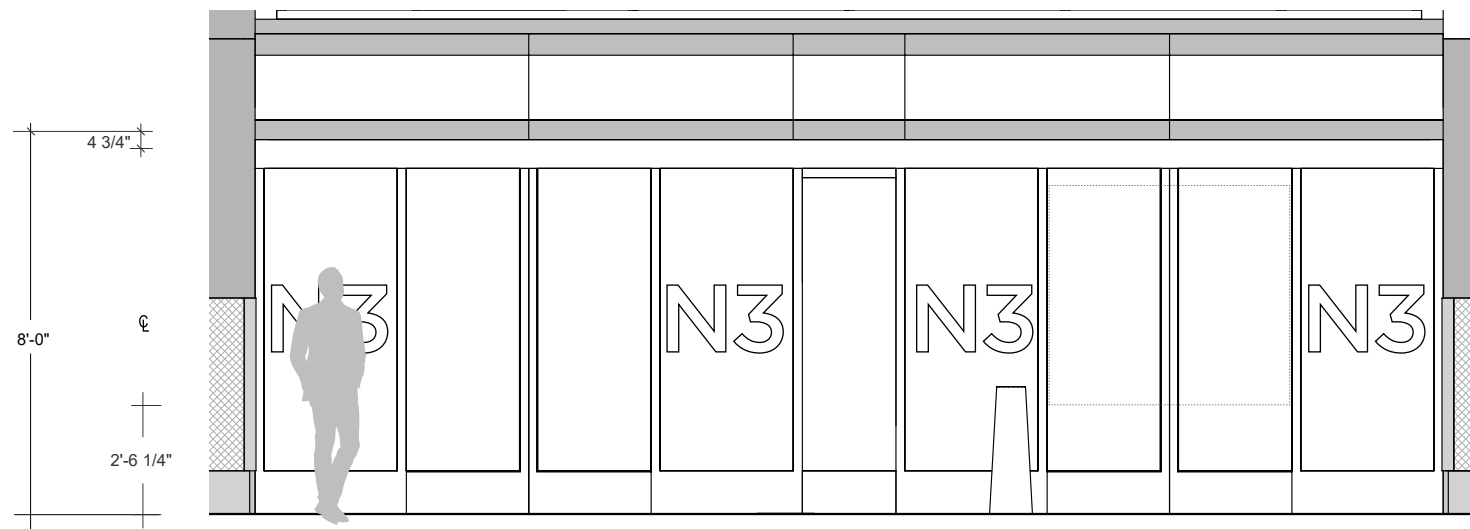

2 ELEVATION
SCALE: 1/4" = 1' - 0"

Descriptions: Door Identification (ALTERNATE)
Dimensions: 2'- 0" Dia.
Location: Upper and Lower Level Curbsides
Material: Exterior Grade Vinyl
Lettering: Gotham Medium
Symbology: N/A
Colors: C1 Door Identification
 - Machine cut opaque white acrylic
Graphics: N/A
Mounting: First surface on glass
Illuminations: None
Remarks: Submit material color for review / approval prior to fabrication.

2.0 SIGN TYPES

#	REVISION	DATE
1	Updated	07/25/17
2	Updated	10/20/17

2.4 Sign Type Layouts



1 SIGN TYPE - REGULATORY VINYL
SCALE: 1" = 1' - 0"



2 ELEVATION
SCALE: 1/4" = 1' - 0"

Regulatory **ST-474**

Descriptions: Regulatory Information

Dimensions: 4'- 0" High x 1'- 6" Wide

Location: Upper and Lower Level Curbsides

Material: Exterior grade Vinyl

Lettering: Gotham Medium

Symbology: Symbol #20, 21, 22

Colors: Black Icon with Regulatory Red circle

Graphics: All graphic content from DOA

Mounting: First surface on glass

Illuminations: None

Remarks: Submit material color for review / approval prior to fabrication.



 Hartsfield-Jackson
Atlanta International Airport®

Prepared by:  AIS |  VALANCOURT
INTERNATIONAL LLC